



LANDING CRAFT, TANK LCT(5)

About the Landing Craft, Tank LCT(5) :

A total of 470 Landing Craft, Tank LCT(5) were built during WWII by five shipyards and eight steel building companies from June 1942 to November of the same year. Overall length was 114 feet and light displacement 133tons that gave them the possibility to embark Sherman tanks, M-7 howitzers or light armor and trucks. Many of them were transferred to Great Britain under the Lend Lease Program and served during the North African, Europe and Pacific Campaigns.

À propos des Landing Craft, Tank LCT(5) :

Un total de 470 LCT(5) pour Landing Craft, Tank(5) ont été construits pendant la Seconde Guerre Mondiale par cinq chantiers navals et huit entreprises de construction métallique de juin 1942 à novembre de la même année. Une longueur de 40,5m et un déplacement de 133 tonnes lui permettait d'emporter des chars Sherman, canons automoteurs M-7 Priest, des blindés légers ou des camions. Un bon nombre a été transféré à la Grande-Bretagne, les LCT(5) ont participé aux campagnes d'Afrique du Nord, de Normandie et du Pacifique.

LCT 5 PARTS

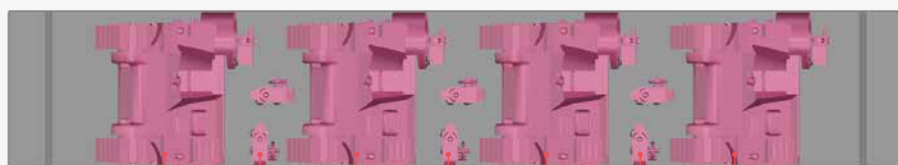
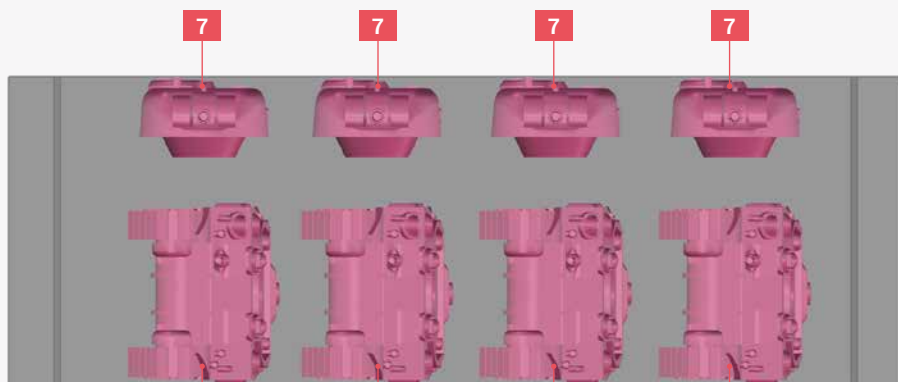
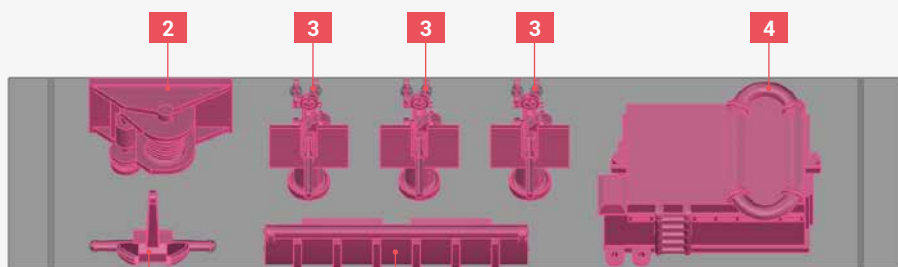
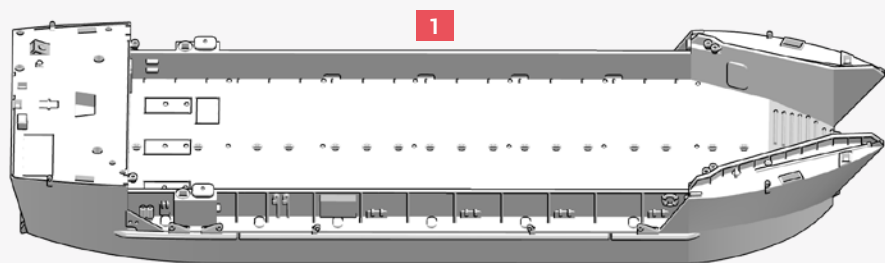

STEP 1

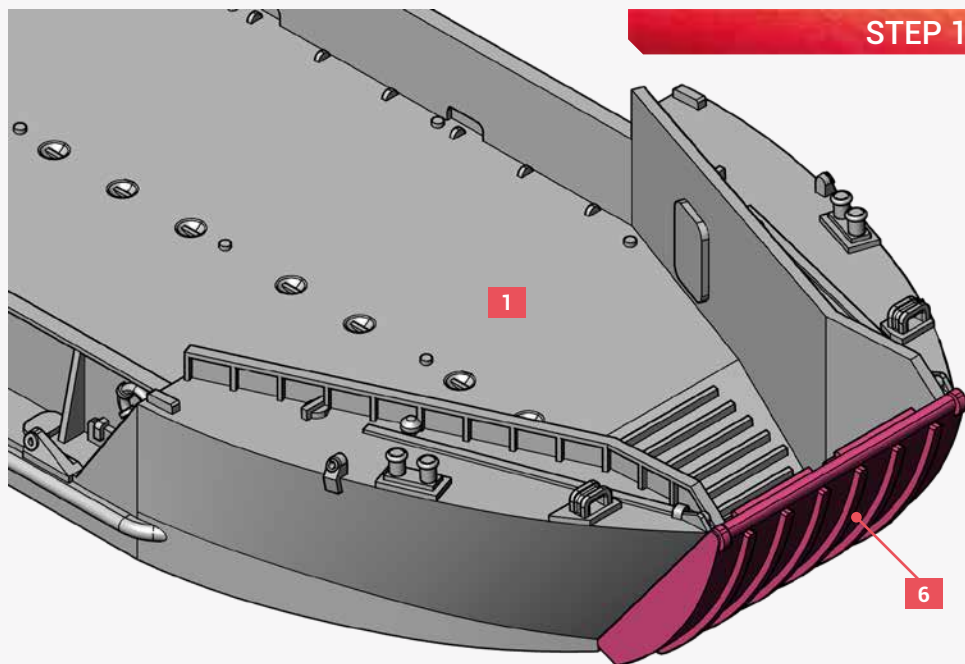

STEP 1

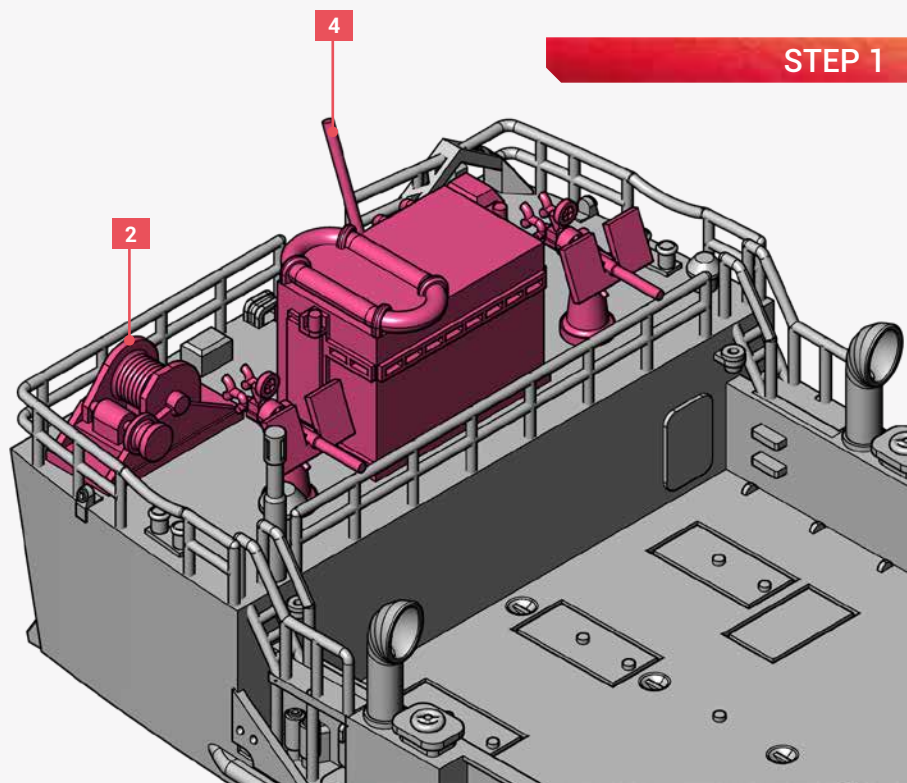

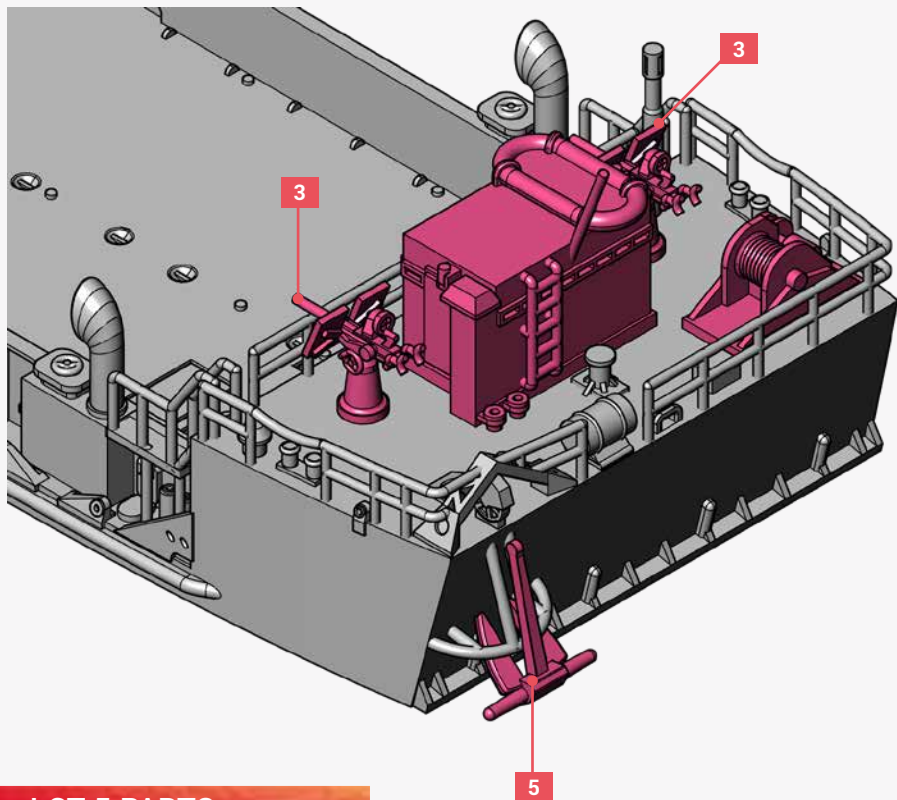

LCT 5 PARTS

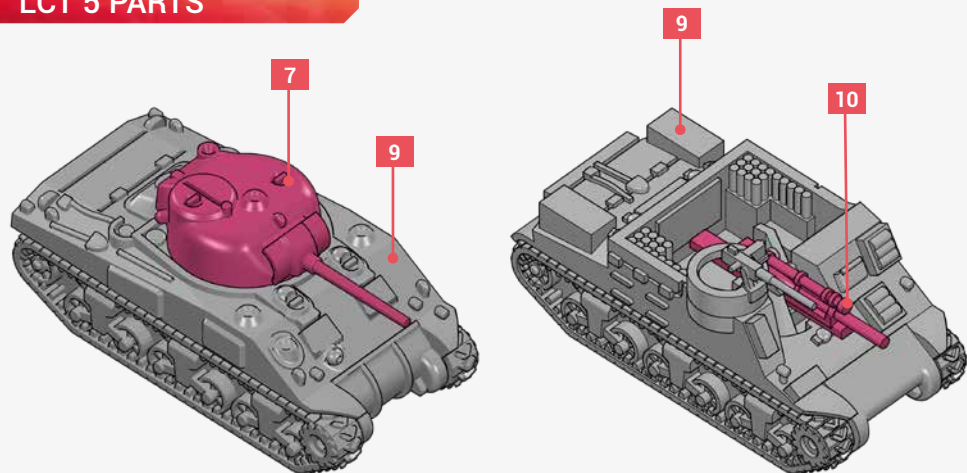

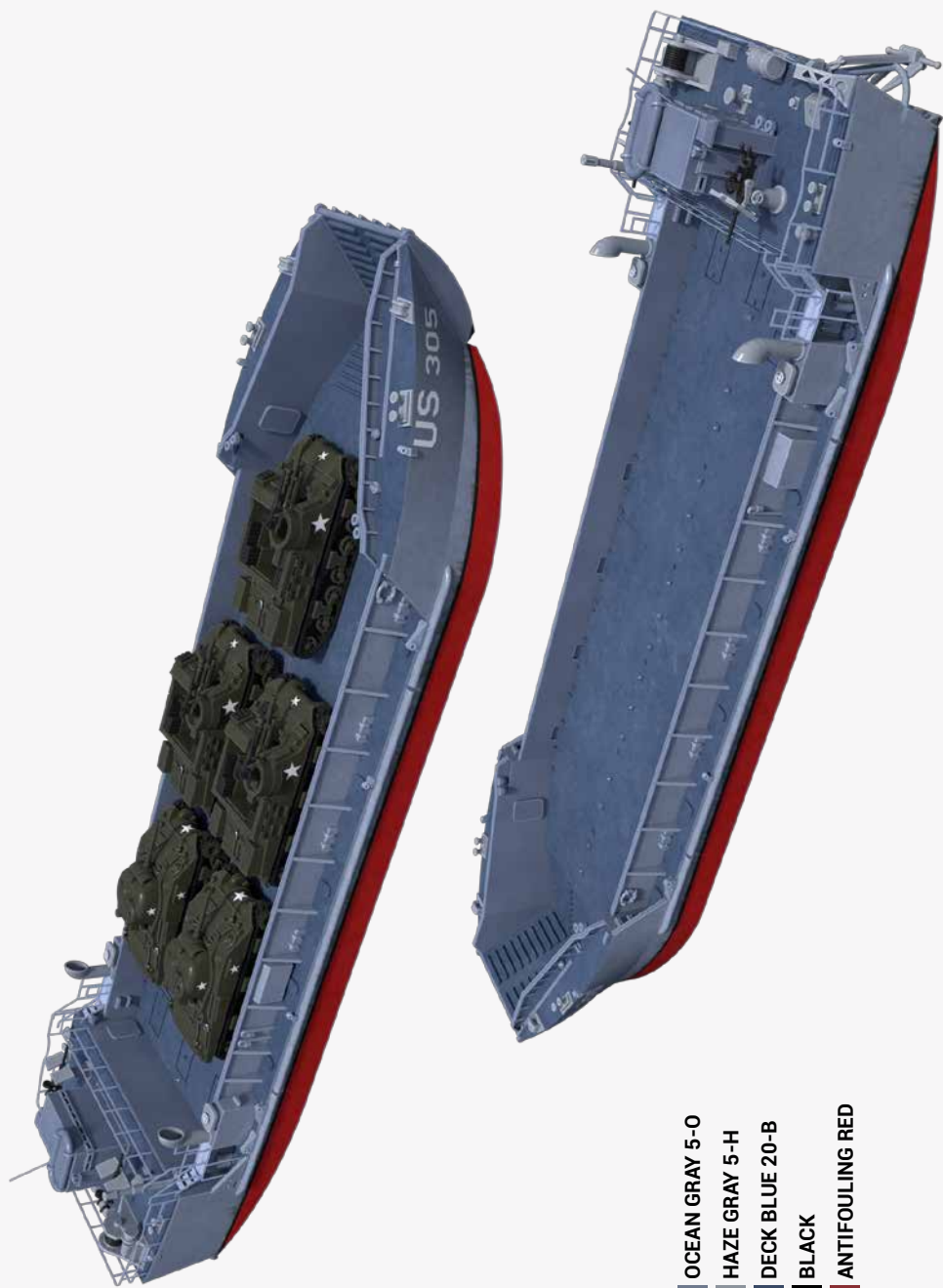

OCEAN GRAY 5-0

HAZE GRAY 5-H

DECK BLUE 20-B

BLACK

ANTIFOULING RED

