



USS CANNON CLASS DE EARLY

700 007a

1/700°



www.blackcatmodels.eu

contact@blackcatmodels.eu

XX	RESIN PARTS
XX	3D PARTS
XX	PHOTOETCH PARTS
XX	BRASS PARTS
XX	DECALS PARTS

!	ASSEMBLY WARNING
PS	PORT & STARBOARD
P	PORT SIDE
S	STARBOARD SIDE
X	INFORMATIONS

SOME PHOTOETCH AND 3D PARTS ARE PROVIDED IN EXTRA NUMBERS.

SOME PARTS ARE PROVIDED FOR CANNON AND EDSALL KITS, MANY PARTS WON'T BE USED IN THIS BUILD.

IMPORTANT ! PLEASE FULLY READ THE INSTRUCTIONS BEFORE STARTING THE BUILD !

PHOTOETCH PARTS

DECALS

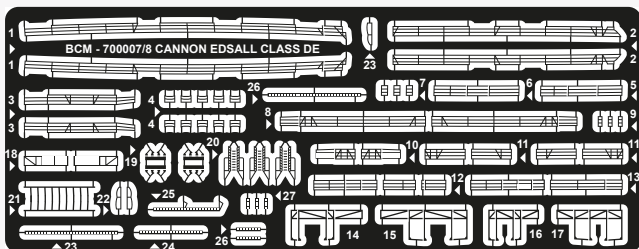

0	0	0	0	0	0
1	1	1	1	1	1
2	2	2	2	2	2
3	3	3	3	3	3
4	4	4	4	4	4
5	5	5	5	5	5
6	6	6	6	6	6
7	7	7	7	7	7
8	8	8	8	8	8
9	9	9	9	9	9

BRASS PARTS

A x1 Ø=0.3MM L=4MM

B x1 Ø=0.3MM L=9MM

C x1 Ø=0.5MM L=29MM

PARTS

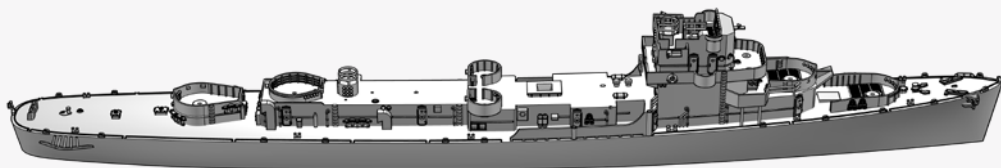

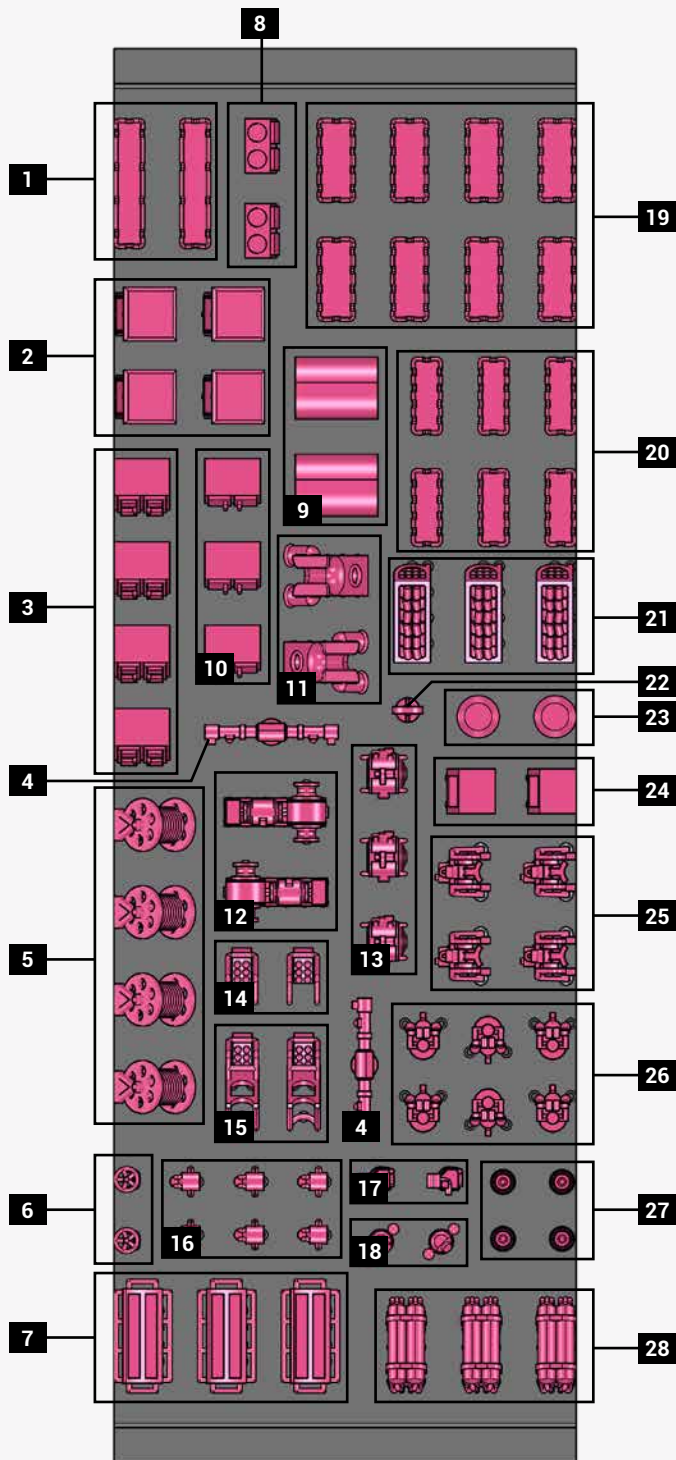

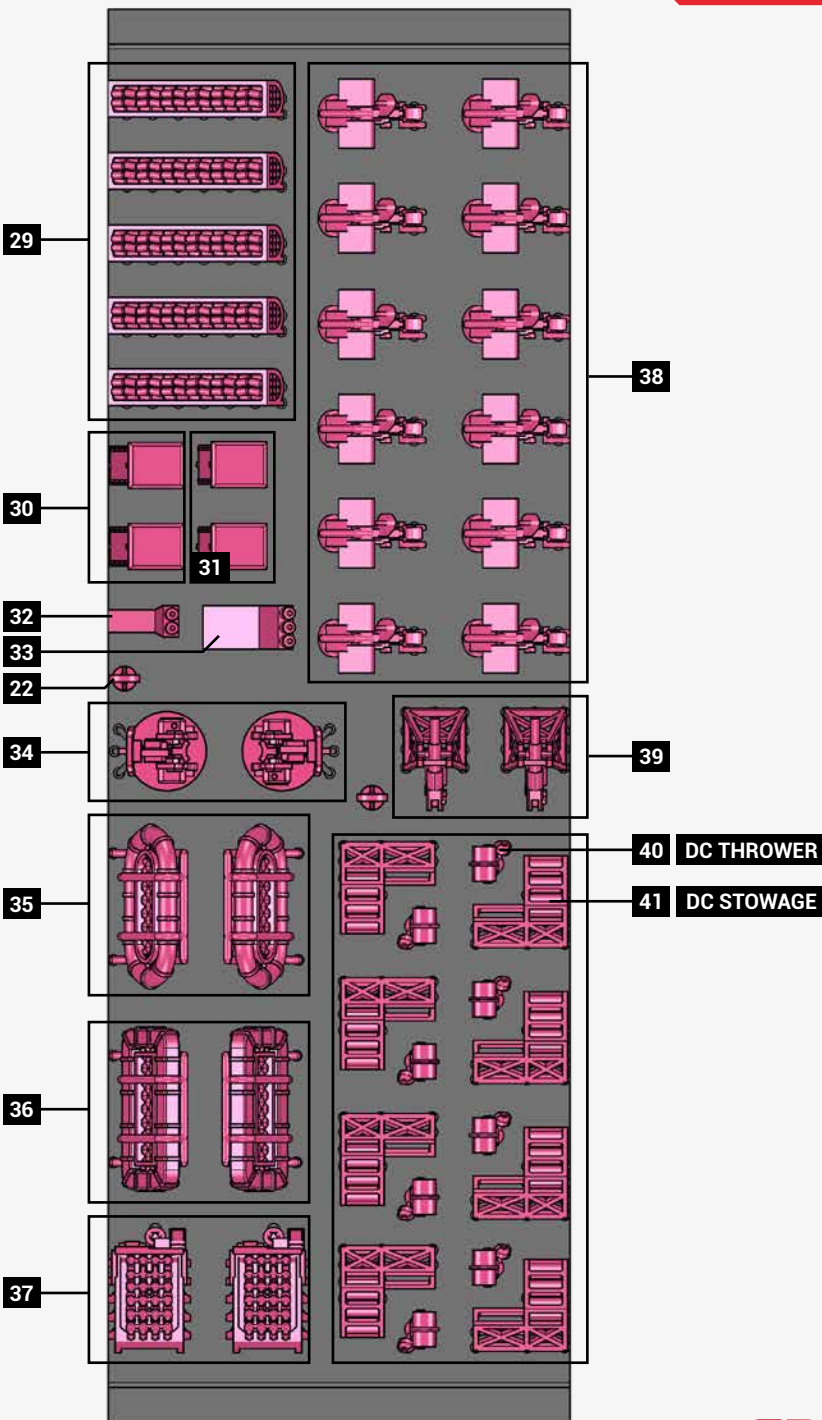

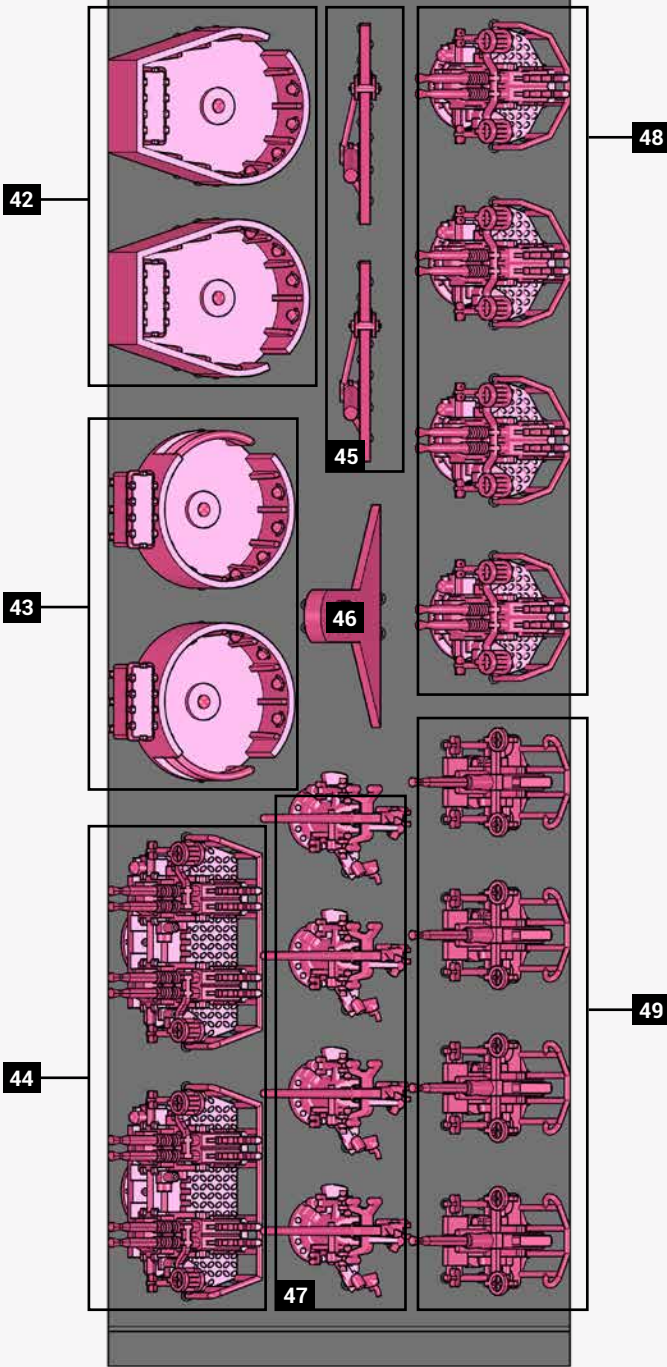

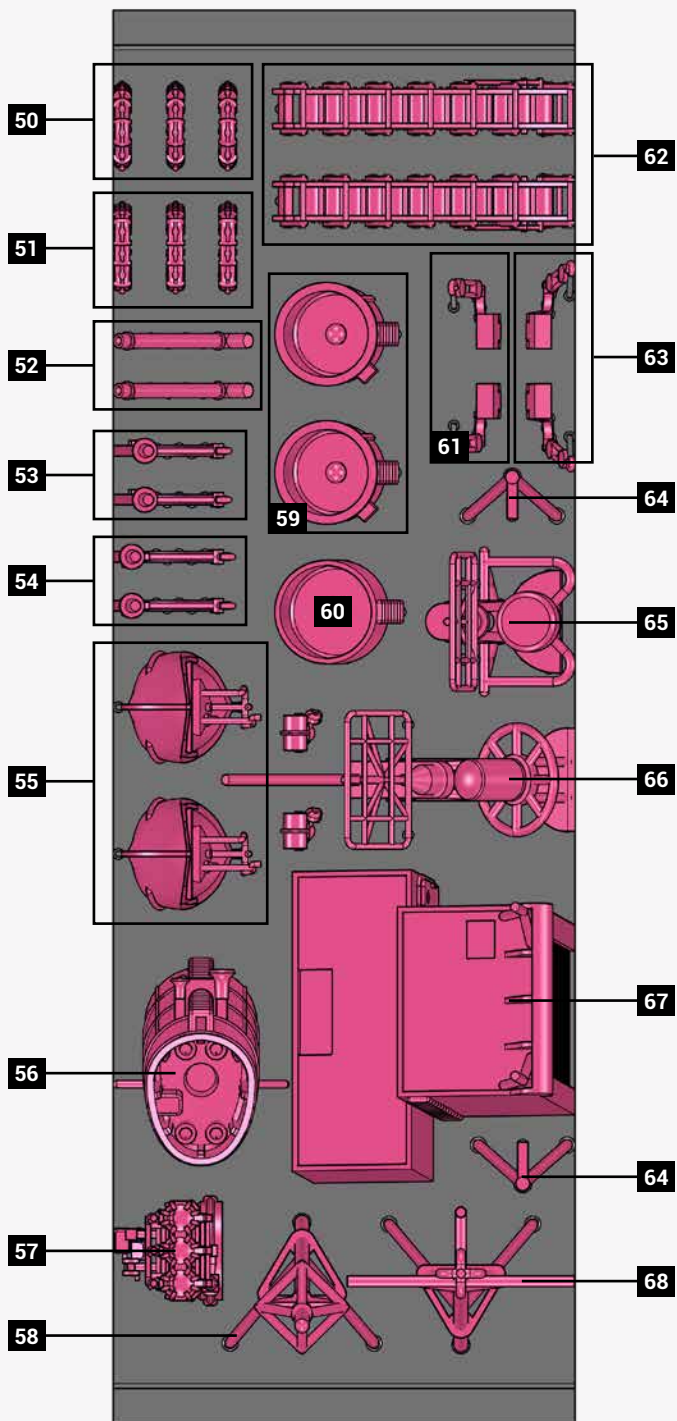

STEP 1

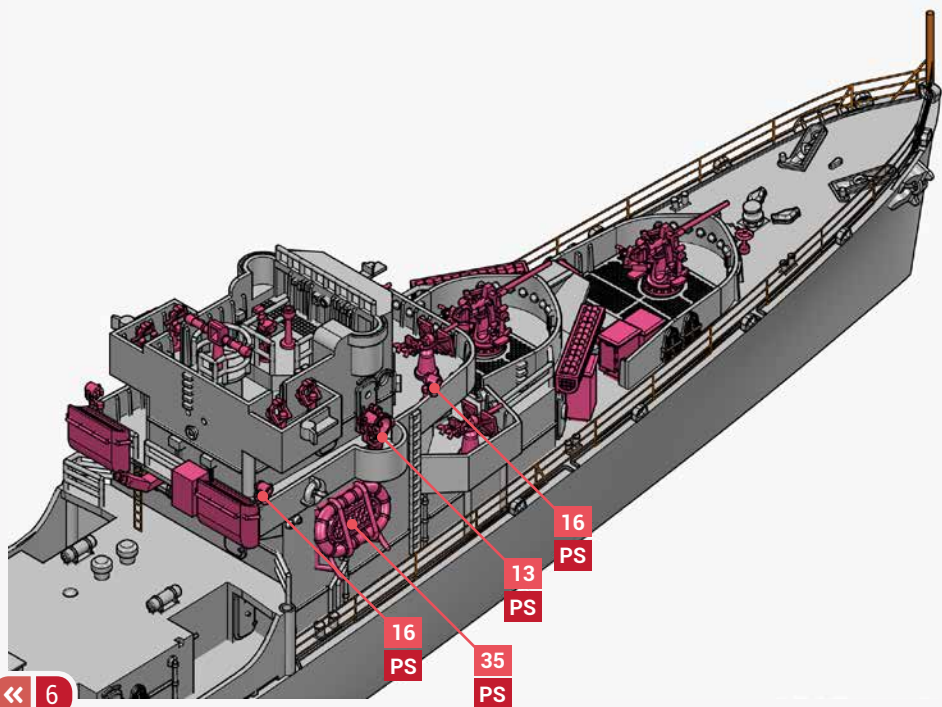
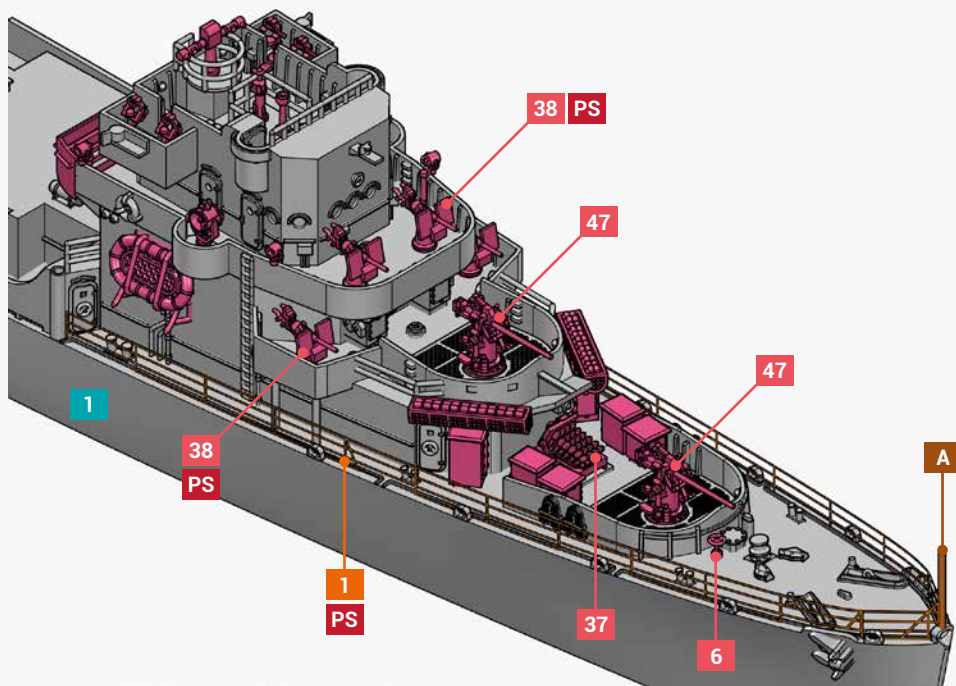

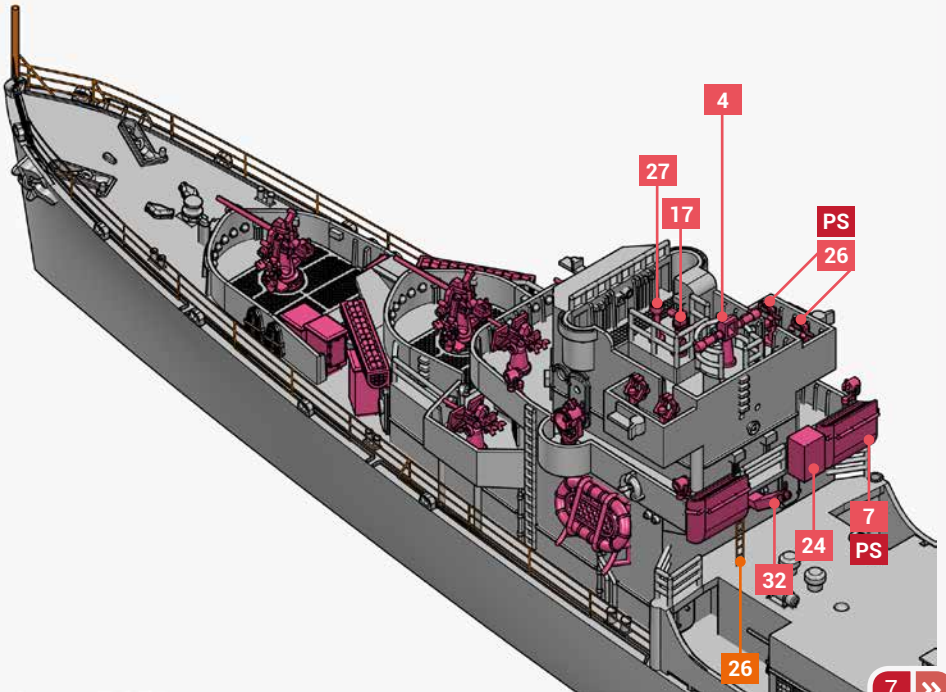
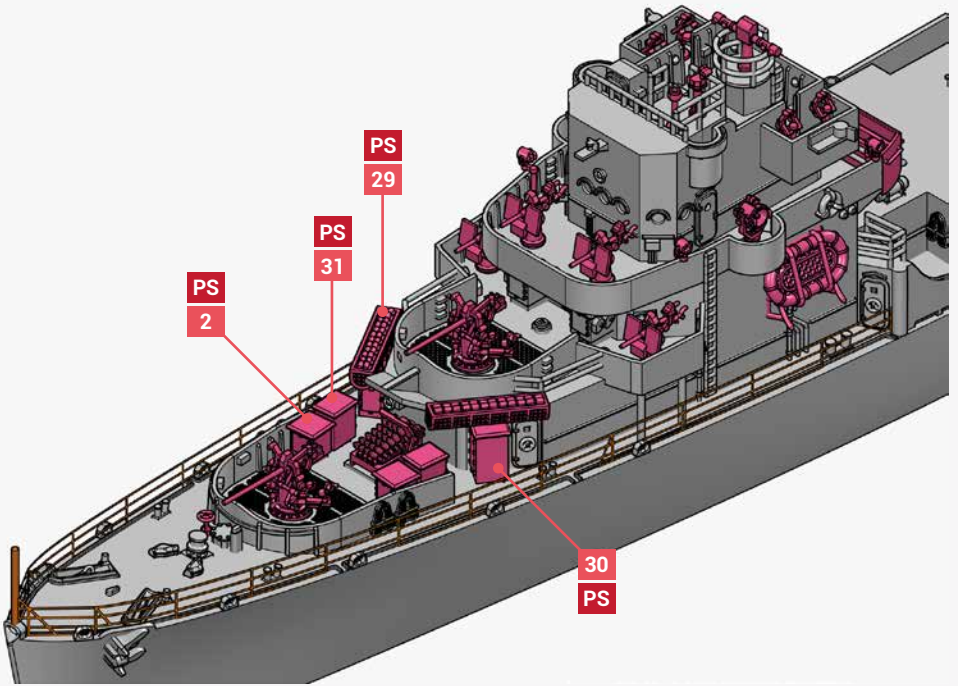

STEP 2

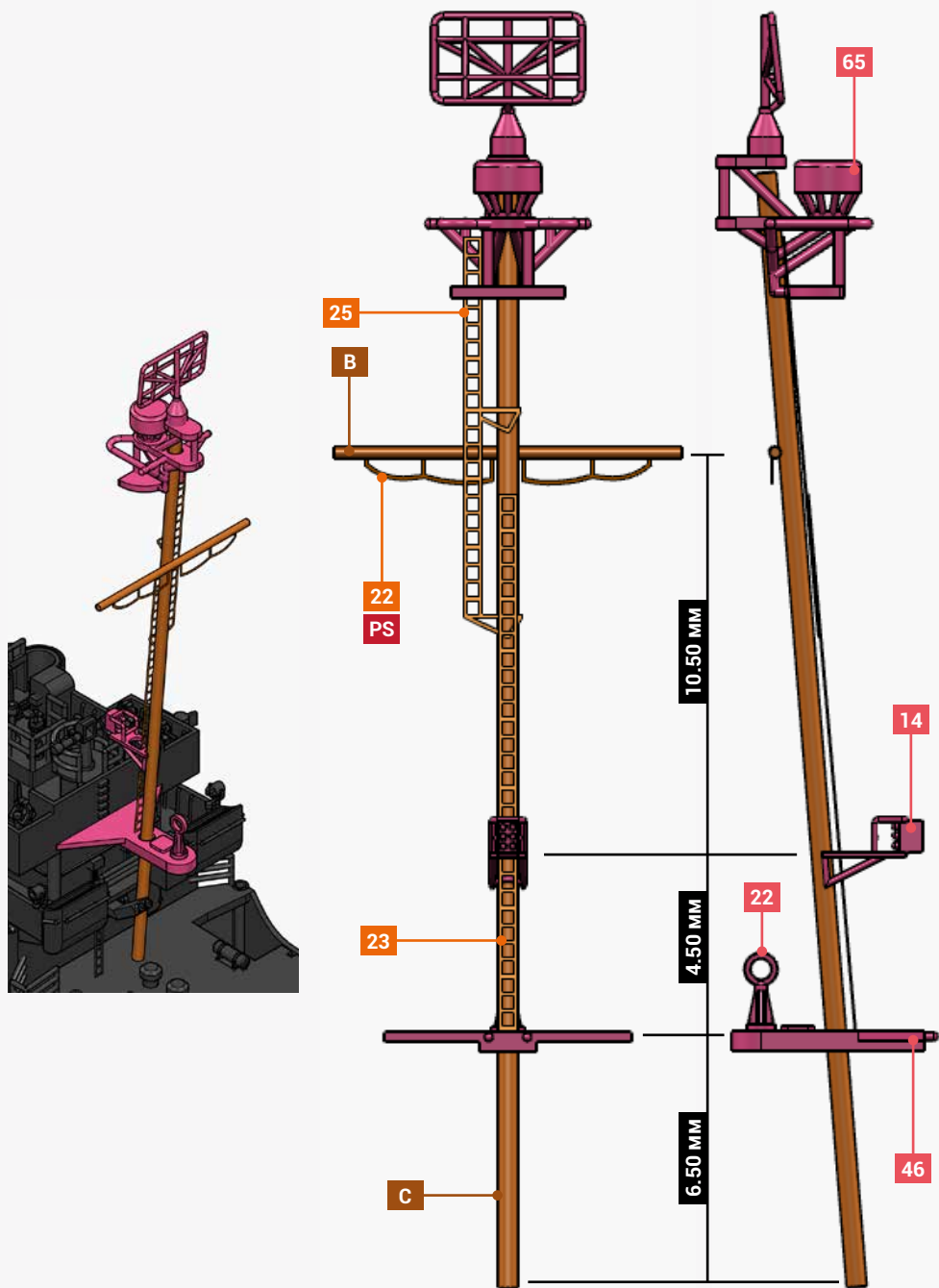

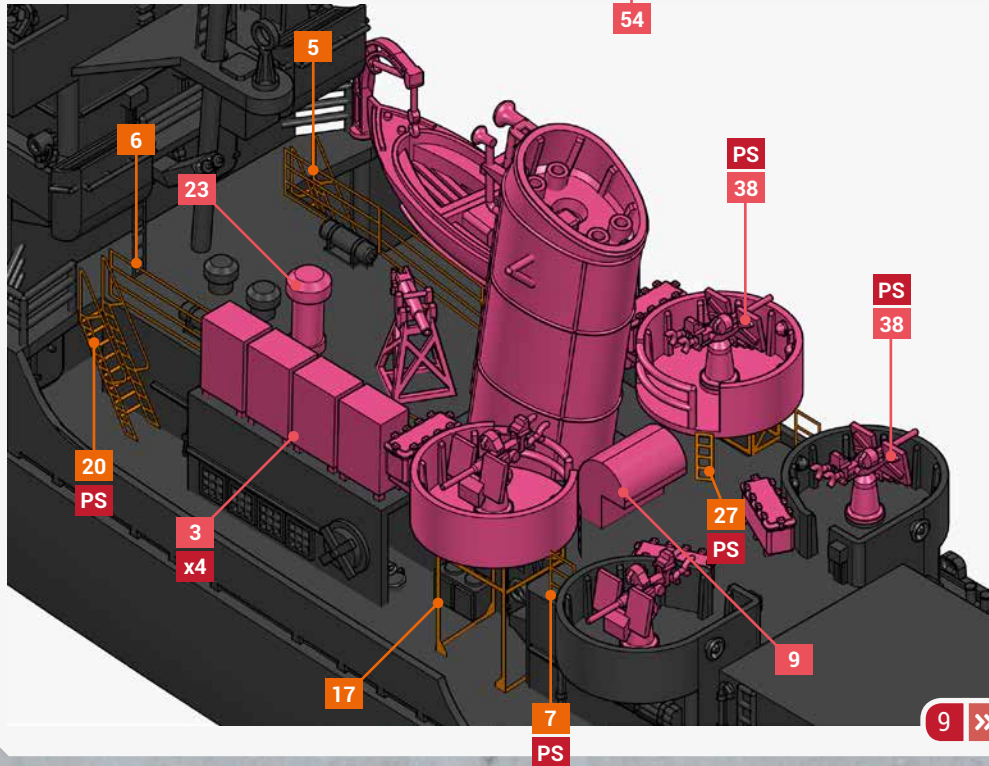
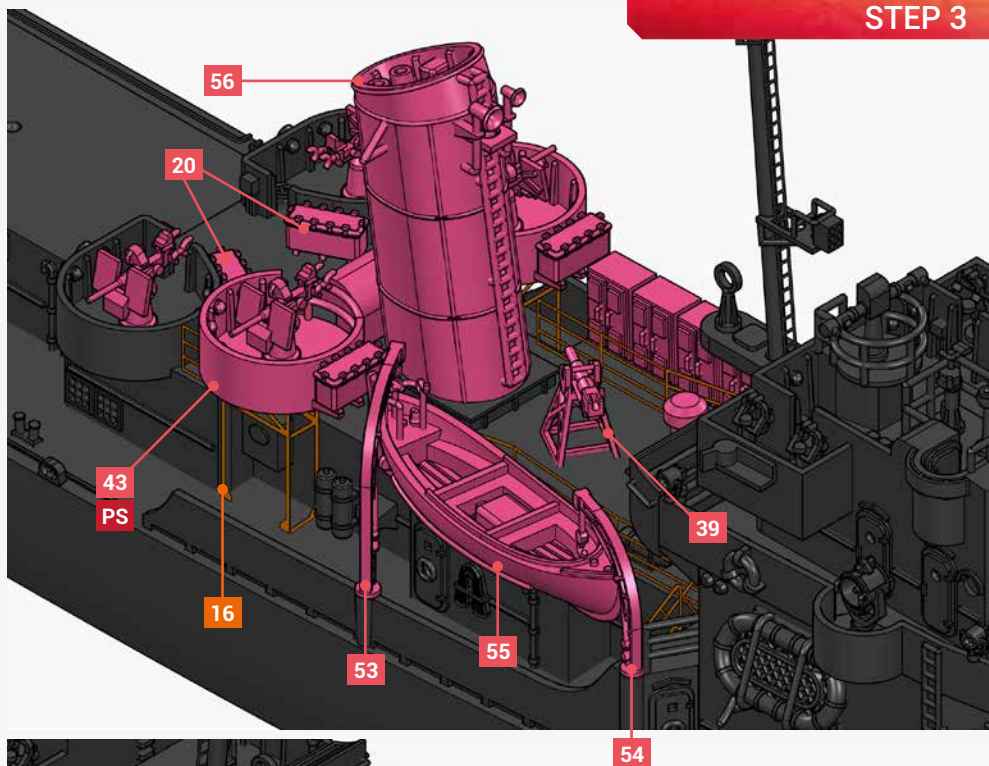

STEP 4

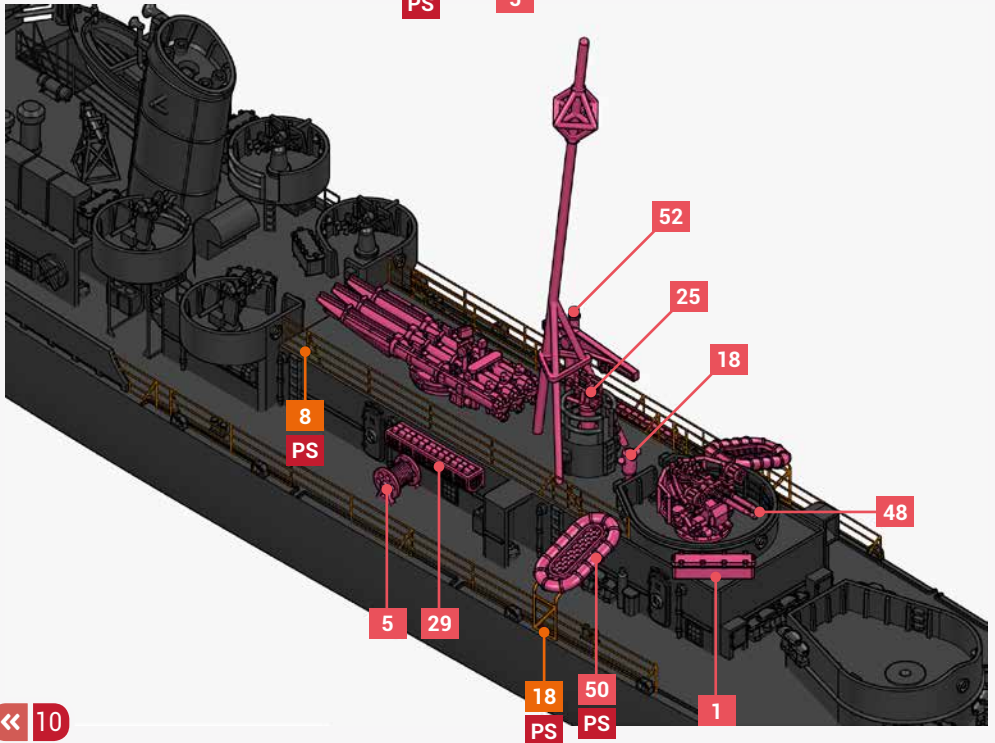
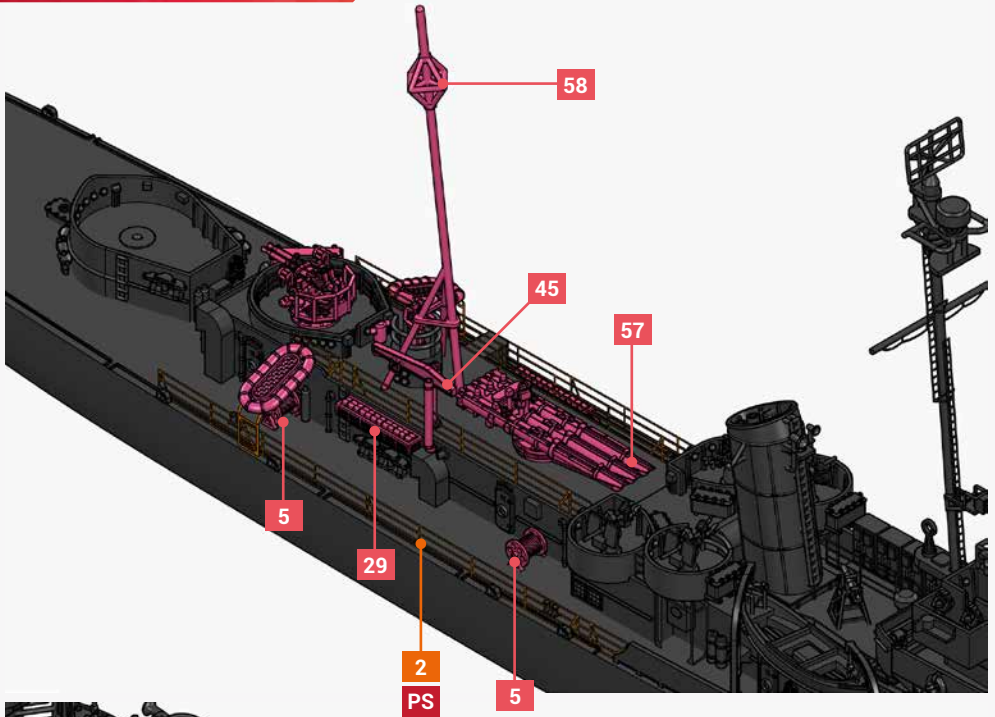

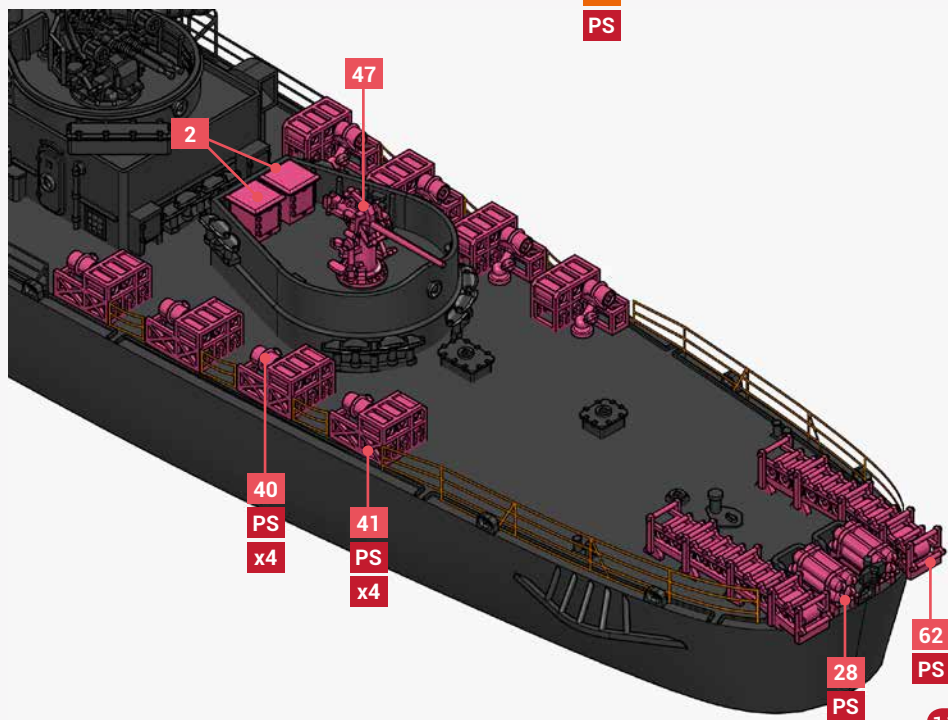
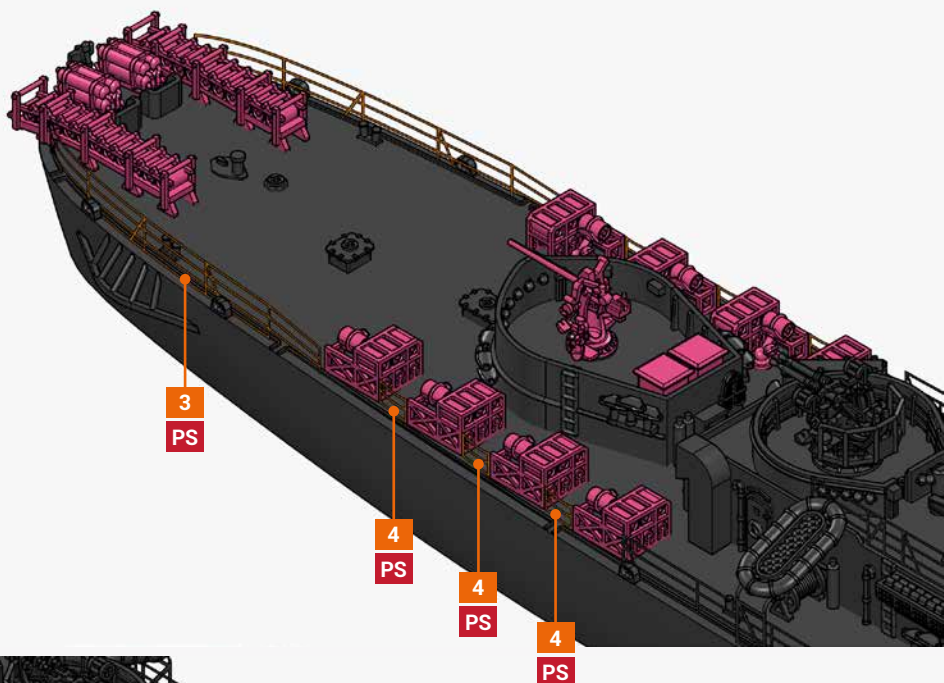

MEASURE 22 WAS USED HERE, BUT THERE ARE MANY VARIATIONS ON THE CLASS CANNON.
FOR MORE INFORMATION PLEASE VISIT :
[HTTPS://WWW.SHIPCAMOUFLAGE.COM/CANNON_CLASS.HTM](https://www.shipcamouflage.com/cannon_class.htm)

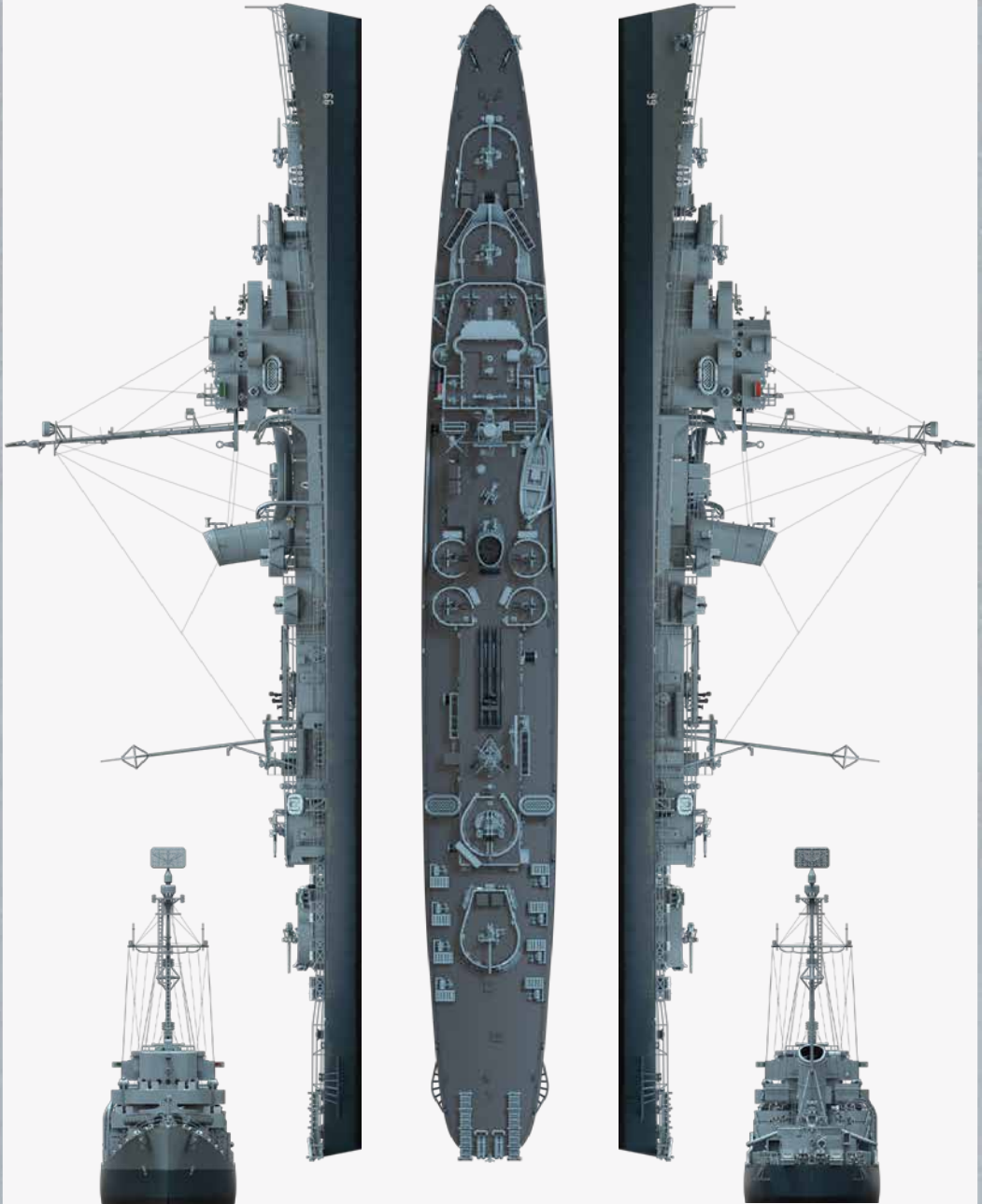

HAZE GRAY 5-H
NAVY BLUE 5-N

DECK BLUE 20-B
BLACK