



[www.blackcatmodels.eu](http://www.blackcatmodels.eu)

[contact@blackcatmodels.eu](mailto:contact@blackcatmodels.eu)

XX	RESIN PARTS
XX	3D PARTS
XX	PHOTOETCH PARTS
XX	BRASS PARTS
XX	DECALS PARTS

!	ASSEMBLY WARNING
PS	PORT & STARBOARD
P	PORT SIDE
S	STARBOARD SIDE
X	INFORMATIONS

SOME PHOTOETCH AND 3D PARTS ARE PROVIDED IN EXTRA NUMBERS.

SOME PARTS ARE PROVIDED FOR CANNON AND EDSALL KITS, MANY PARTS WON'T BE USED IN THIS BUILD.

IMPORTANT ! PLEASE FULLY READ THE INSTRUCTIONS BEFORE STARTING THE BUILD !

## PHOTOETCH PARTS

## DECALS

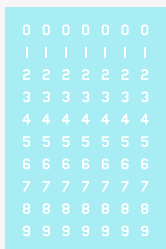
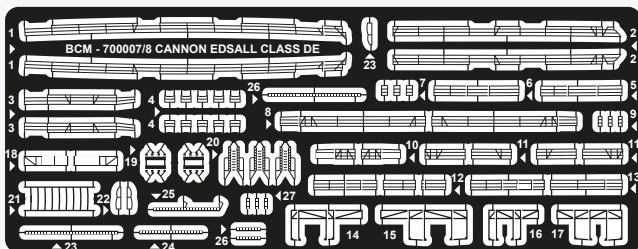

## BRASS PARTS

A x1 Ø=0.3mm L=4mm

B x1 Ø=0.3mm L=9mm

C x1 Ø=0.5mm L=29mm

## PARTS

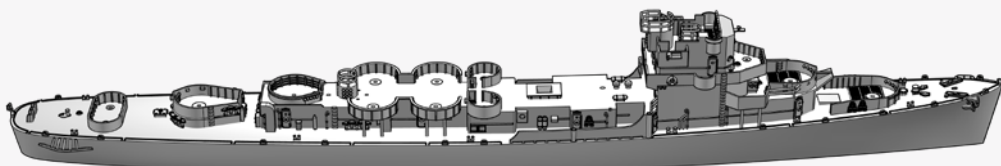

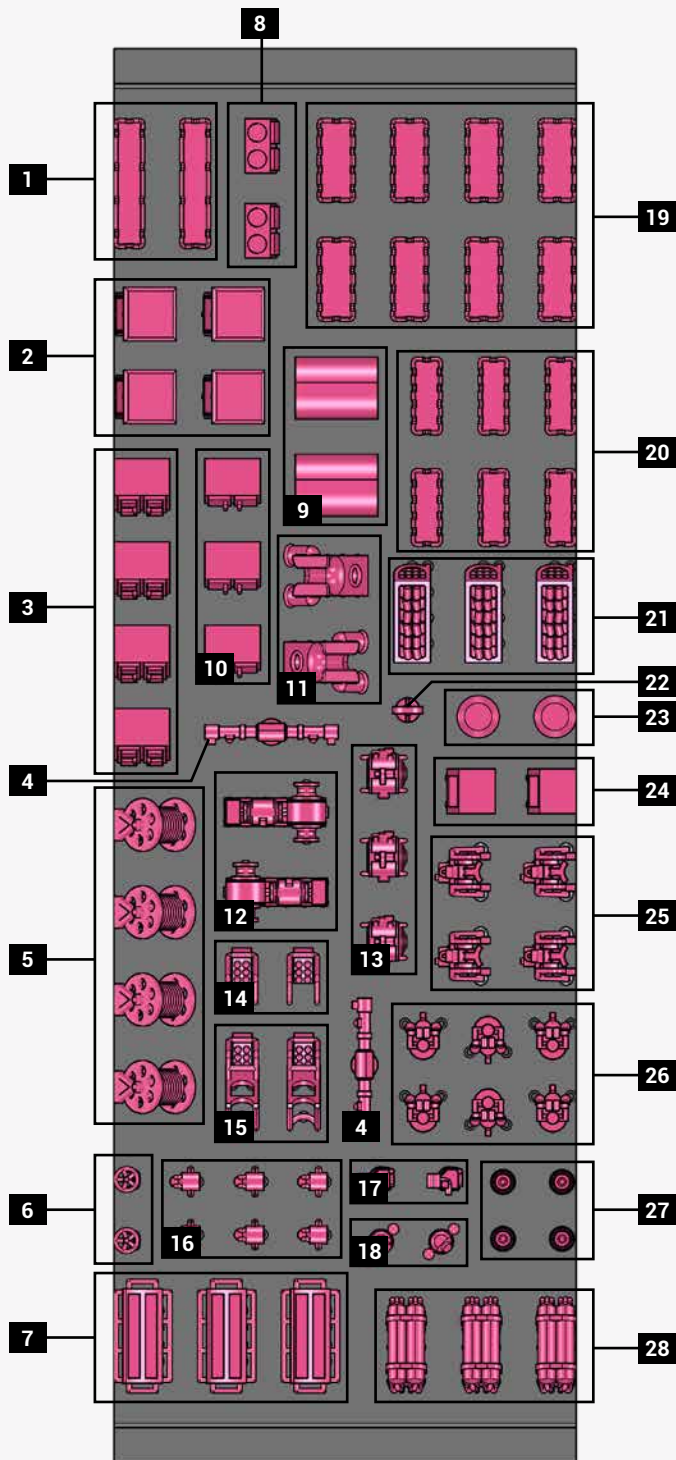

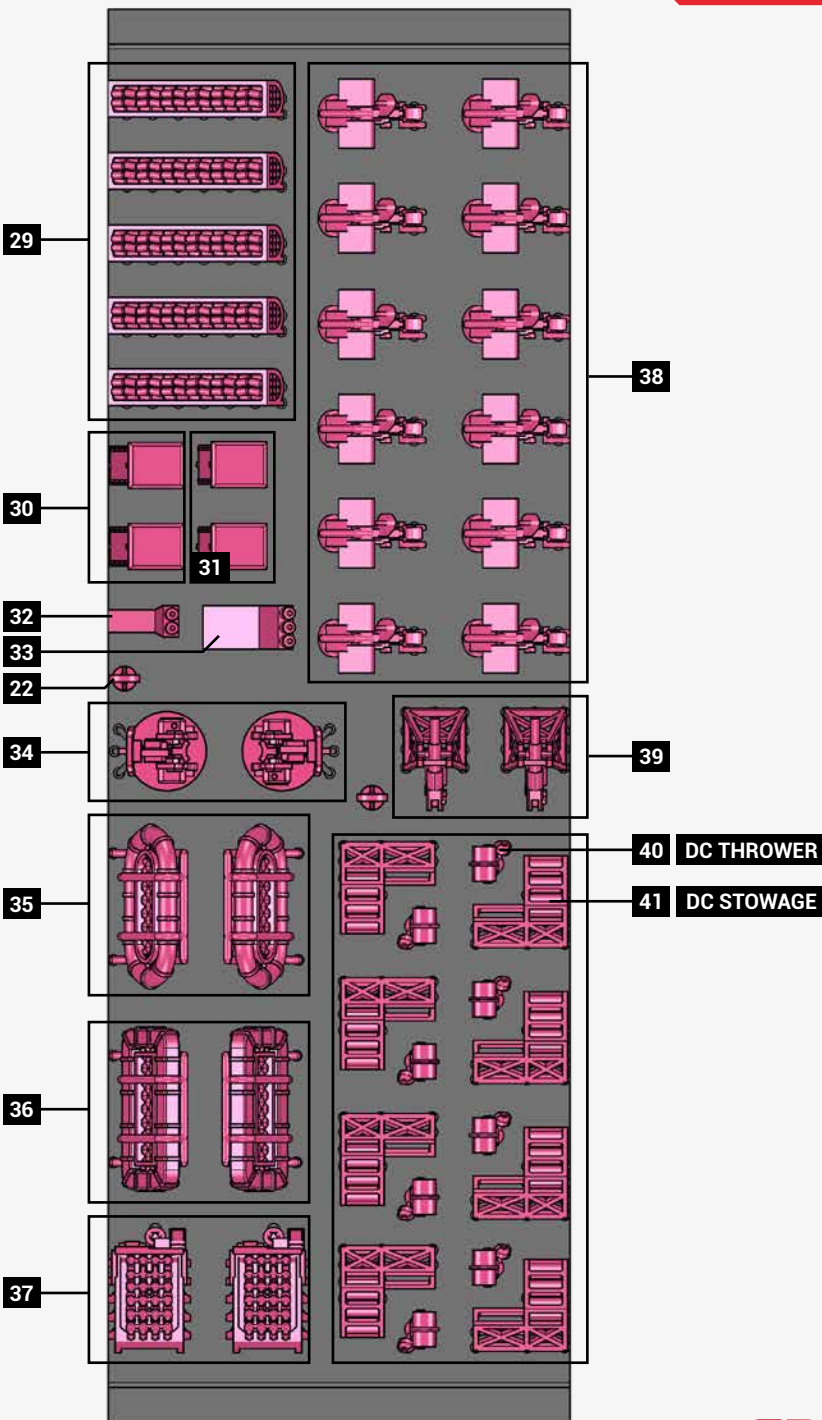

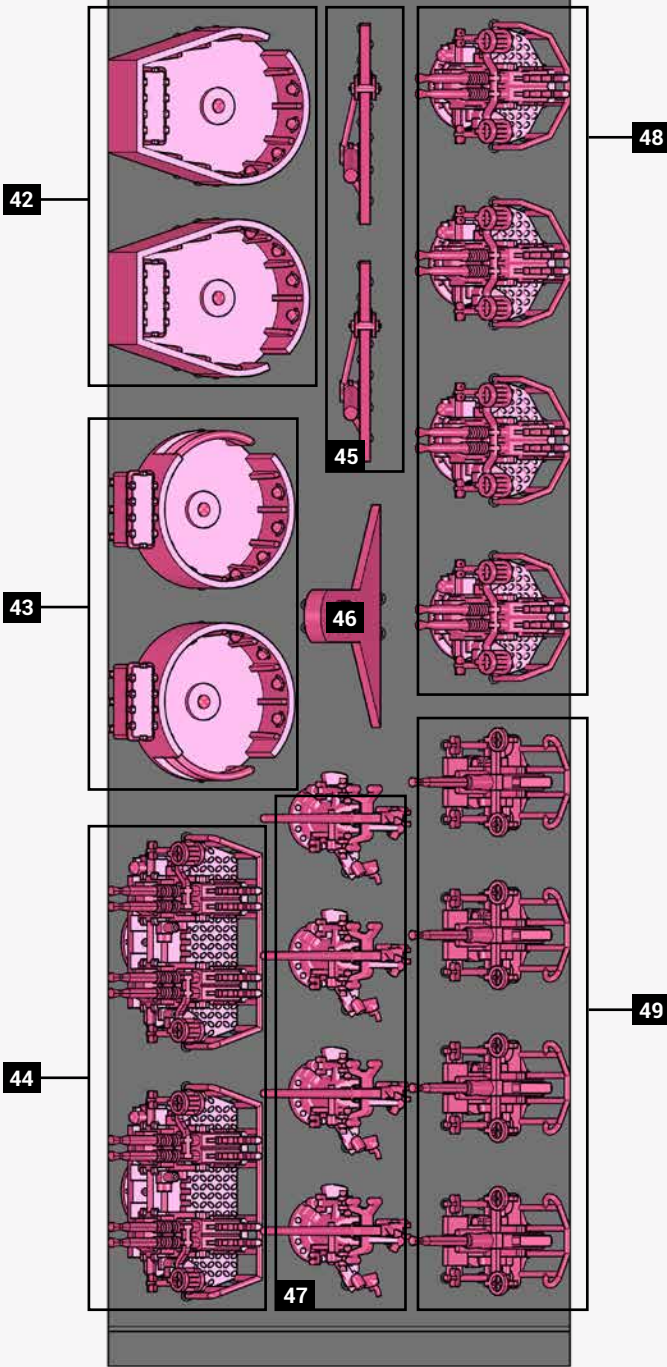

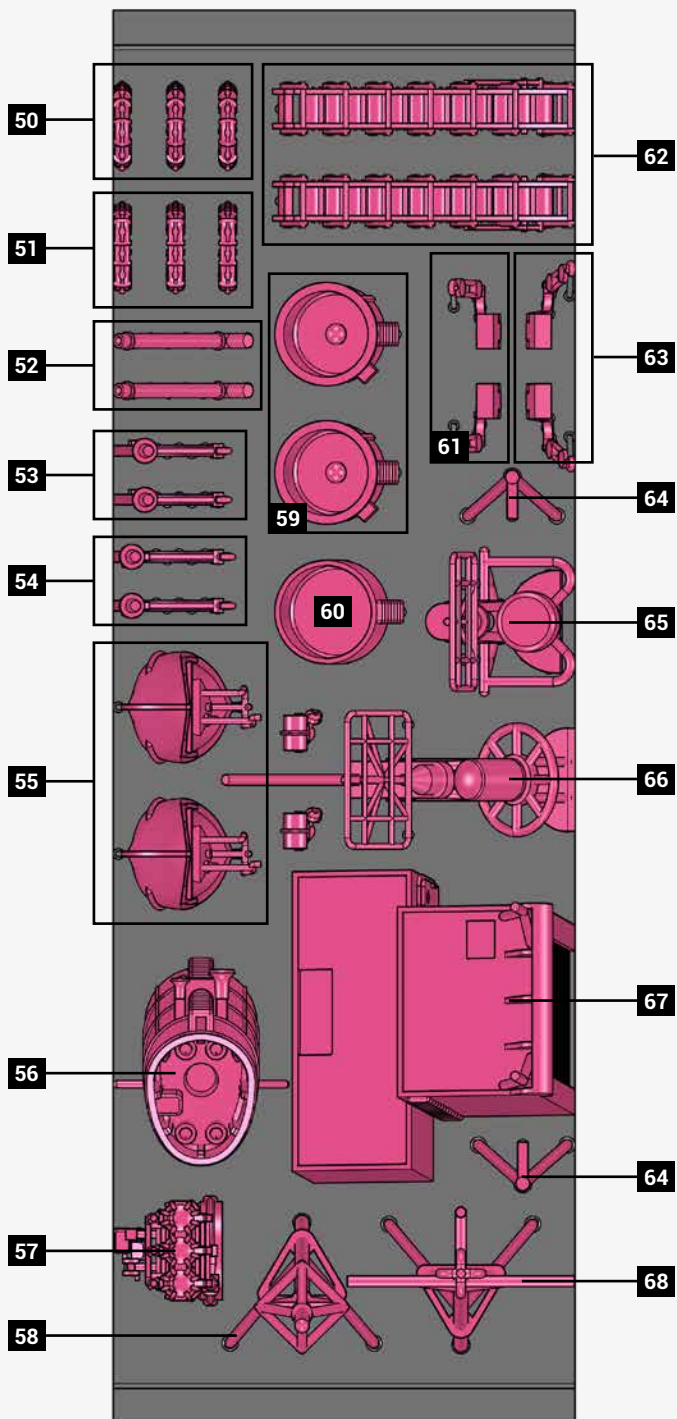

# STEP 1

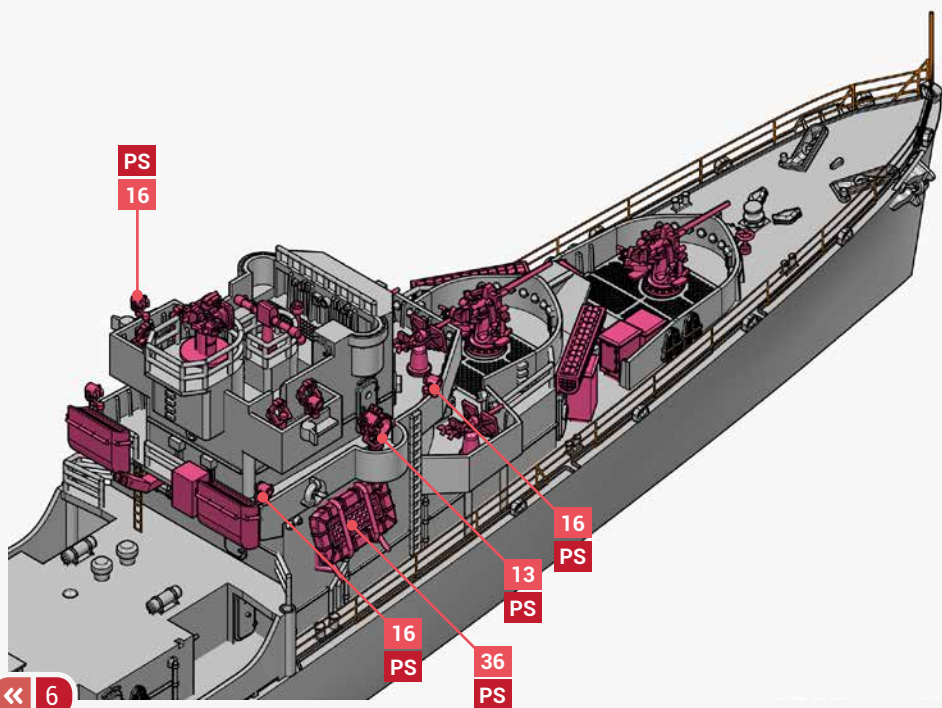
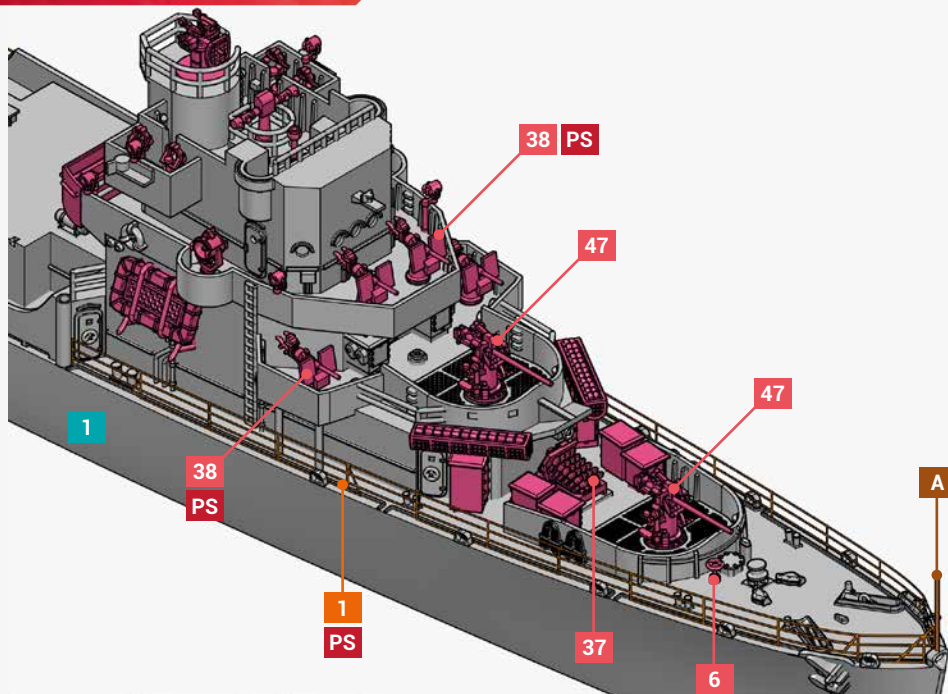

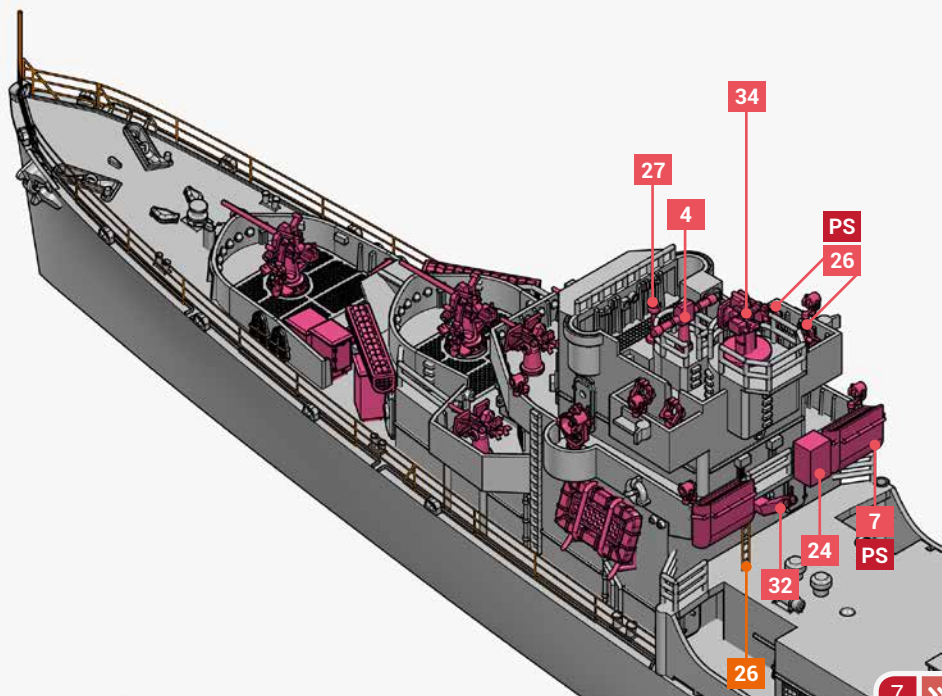
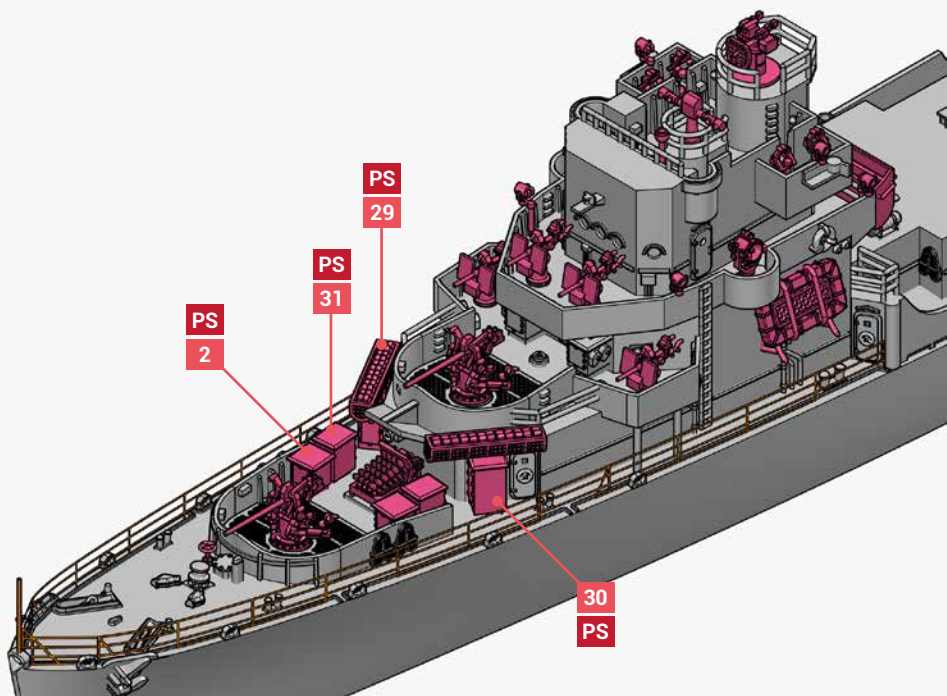

# STEP 2

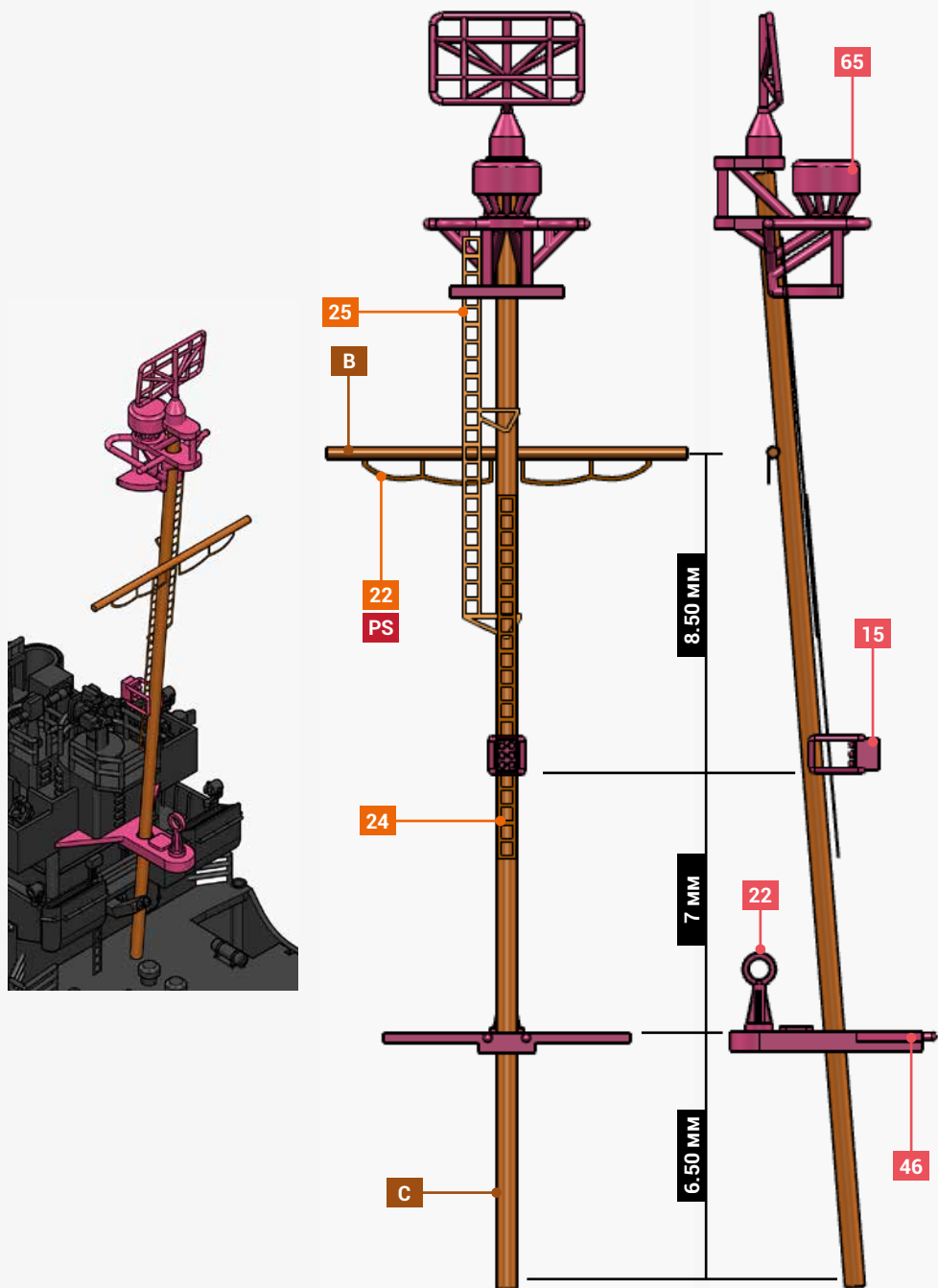

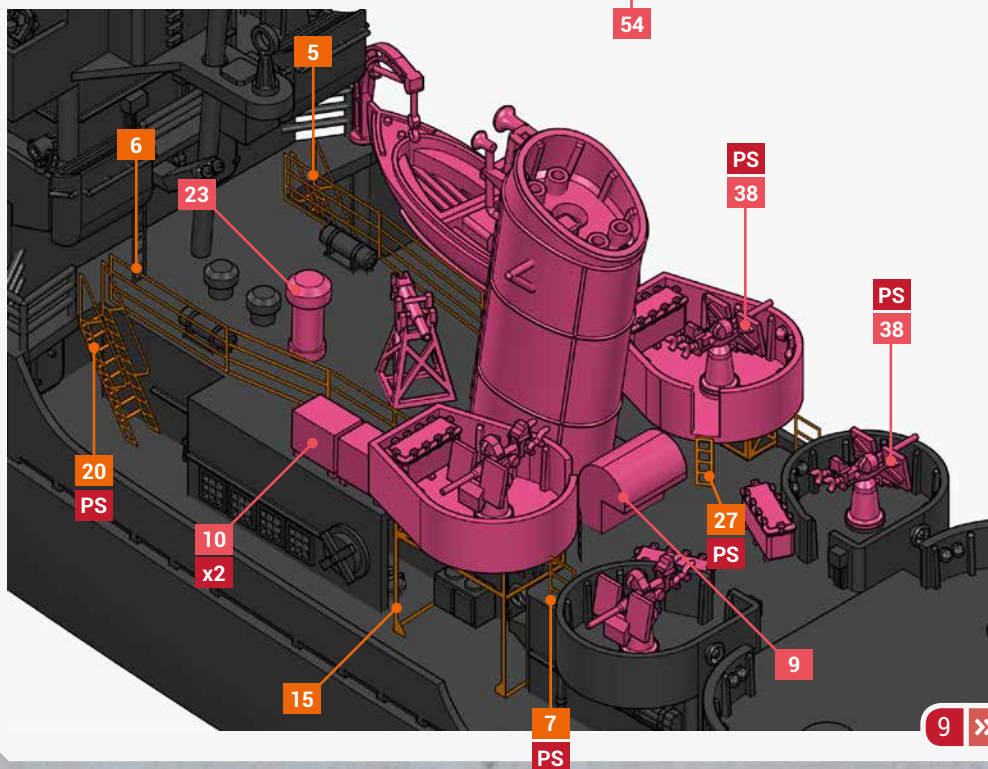
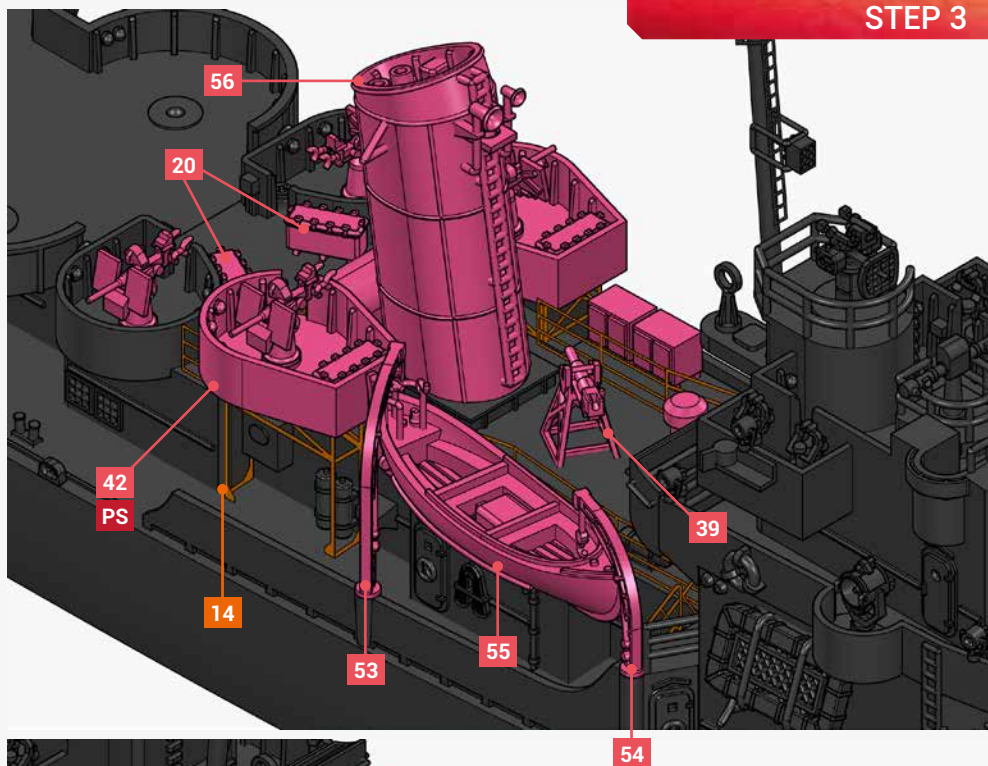

# STEP 4

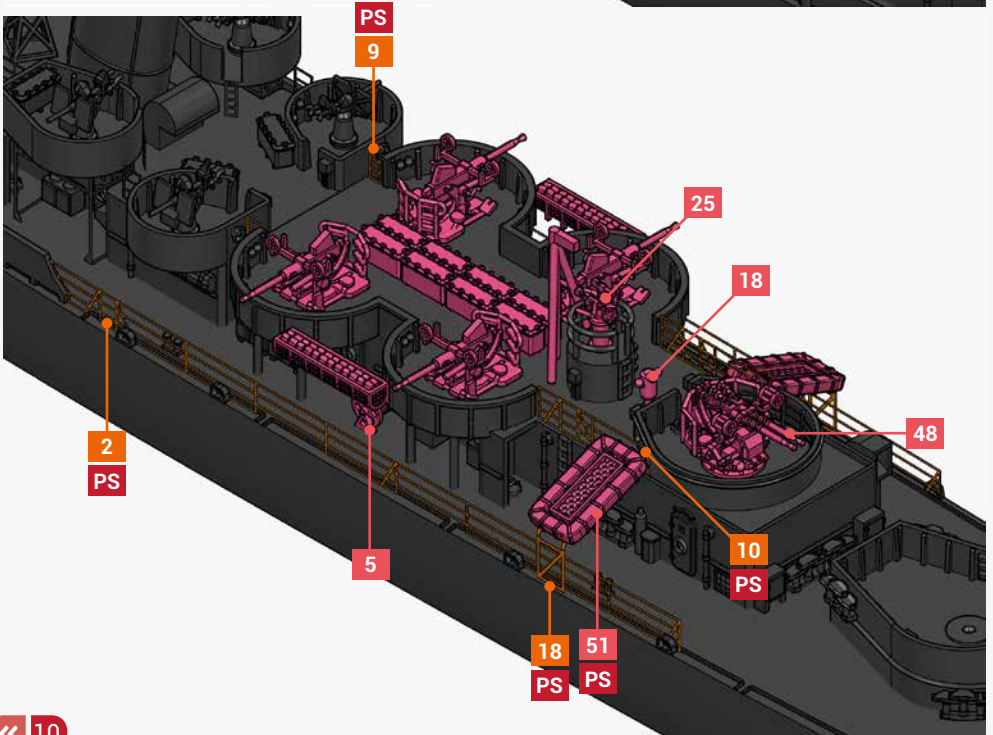
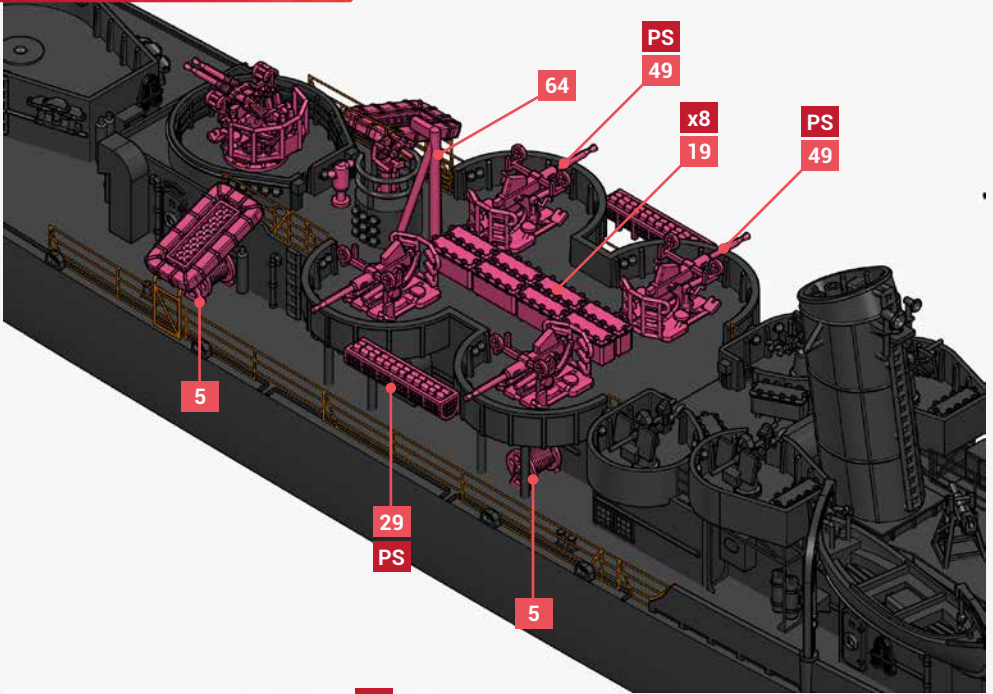

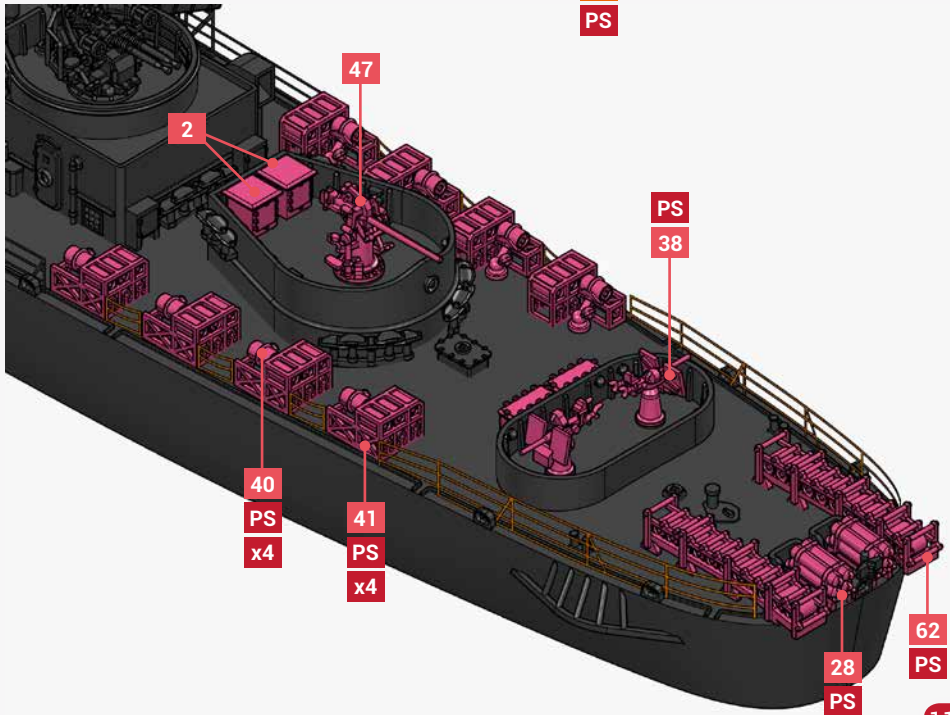
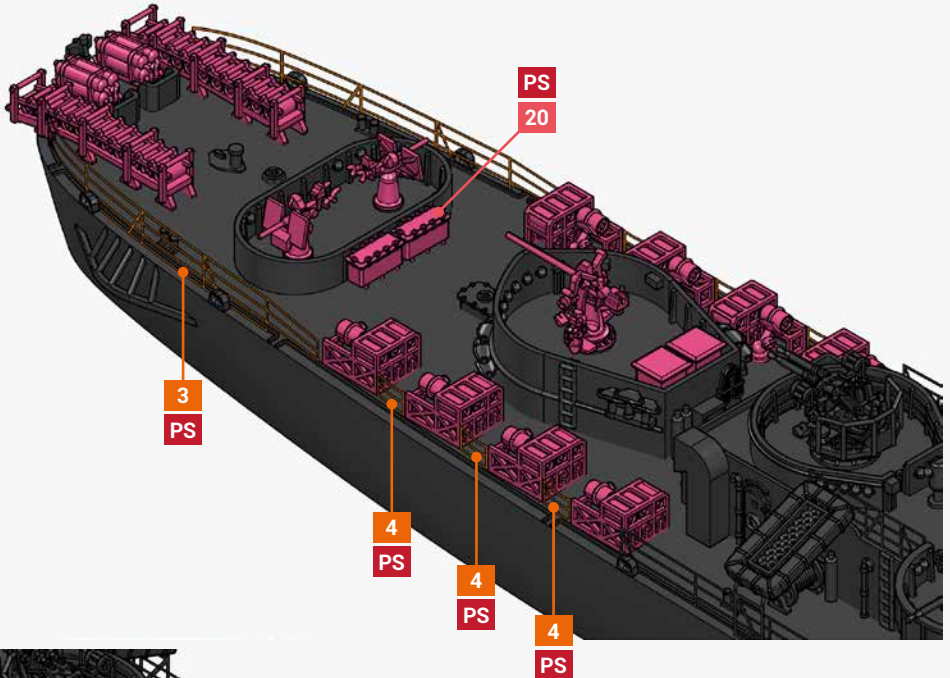

MEASURE 32/MOD3D WAS USED HERE, BUT THERE ARE MANY VARIATIONS ON THE CLASS CANNON.  
FOR MORE INFORMATION PLEASE VISIT :  
[HTTPS://WWW.SHIPCAMOUFLAGE.COM/CANNON\\_CLASS.HTM](https://www.shipcamouflage.com/cannon_class.htm)

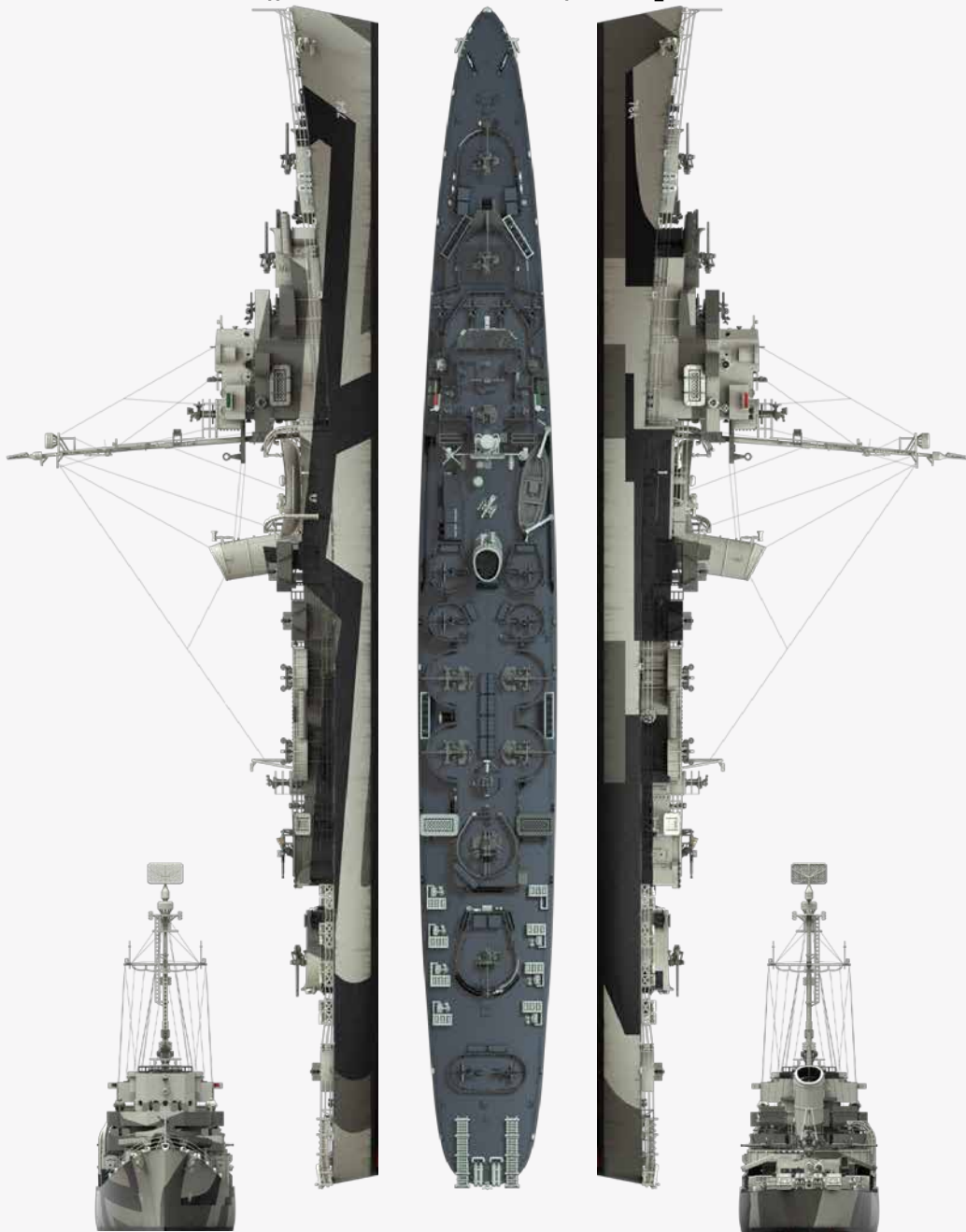

-  OCEAN GRAY 5-O
-  DECK BLUE 20-B
-  LIGHT GRAY 5-L
-  BLACK