



# USS CANNON CLASS DE SLATER



700.007c

1/700°



[www.blackcatmodels.eu](http://www.blackcatmodels.eu)

[contact@blackcatmodels.eu](mailto:contact@blackcatmodels.eu)

XX	RESIN PARTS
XX	3D PARTS
XX	PHOTOETCH PARTS
XX	BRASS PARTS
XX	DECALS PARTS

!	ASSEMBLY WARNING
PS	PORT & STARBOARD
P	PORT SIDE
S	STARBOARD SIDE
X	INFORMATIONS

SOME PHOTOETCH AND 3D PARTS ARE PROVIDED IN EXTRA NUMBERS.

SOME PARTS ARE PROVIDED FOR CANNON AND EDSALL KITS, MANY PARTS WON'T BE USED IN THIS BUILD.

IMPORTANT ! PLEASE FULLY READ THE INSTRUCTIONS BEFORE STARTING THE BUILD !

## PHOTOETCH PARTS

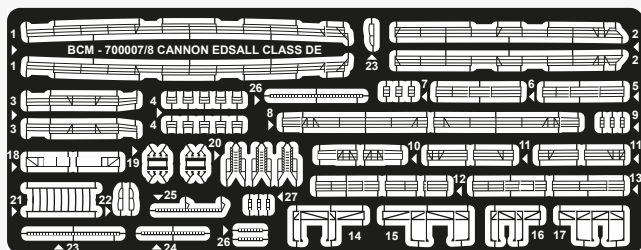

## DECALS

0	0	0	0	0	0	0	0
1	1	1	1	1	1	1	1
2	2	2	2	2	2	2	2
3	3	3	3	3	3	3	3
4	4	4	4	4	4	4	4
5	5	5	5	5	5	5	5
6	6	6	6	6	6	6	6
7	7	7	7	7	7	7	7
8	8	8	8	8	8	8	8
9	9	9	9	9	9	9	9

## BRASS PARTS

A	x1	Ø=0.3MM L=4MM	B	x1	Ø=0.3MM L=9MM	C	x1	Ø=0.5MM L=29MM
---	----	---------------	---	----	---------------	---	----	----------------

## PARTS

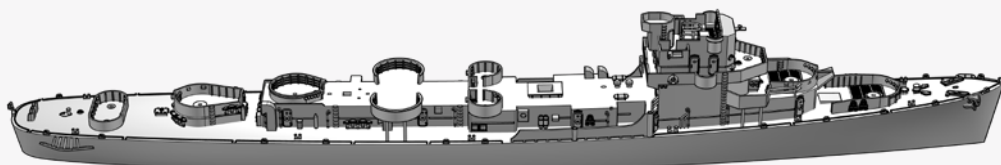

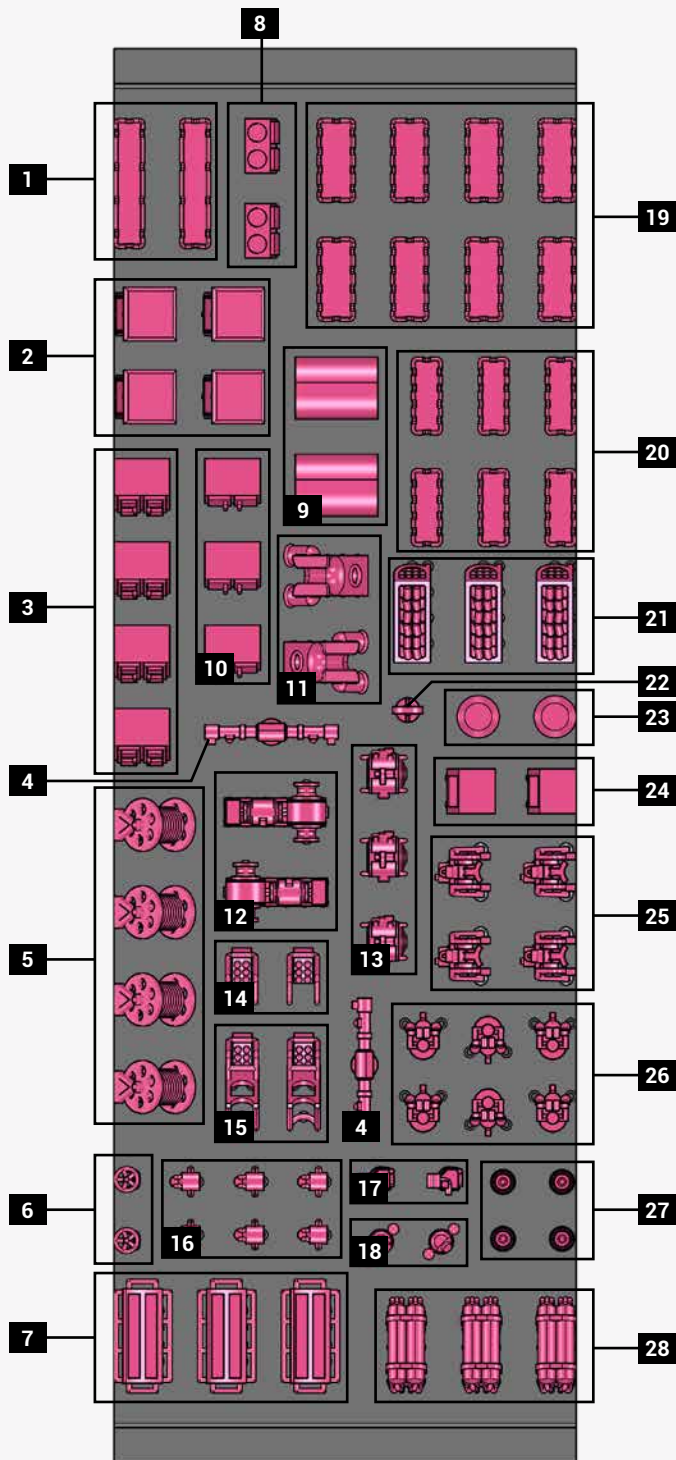

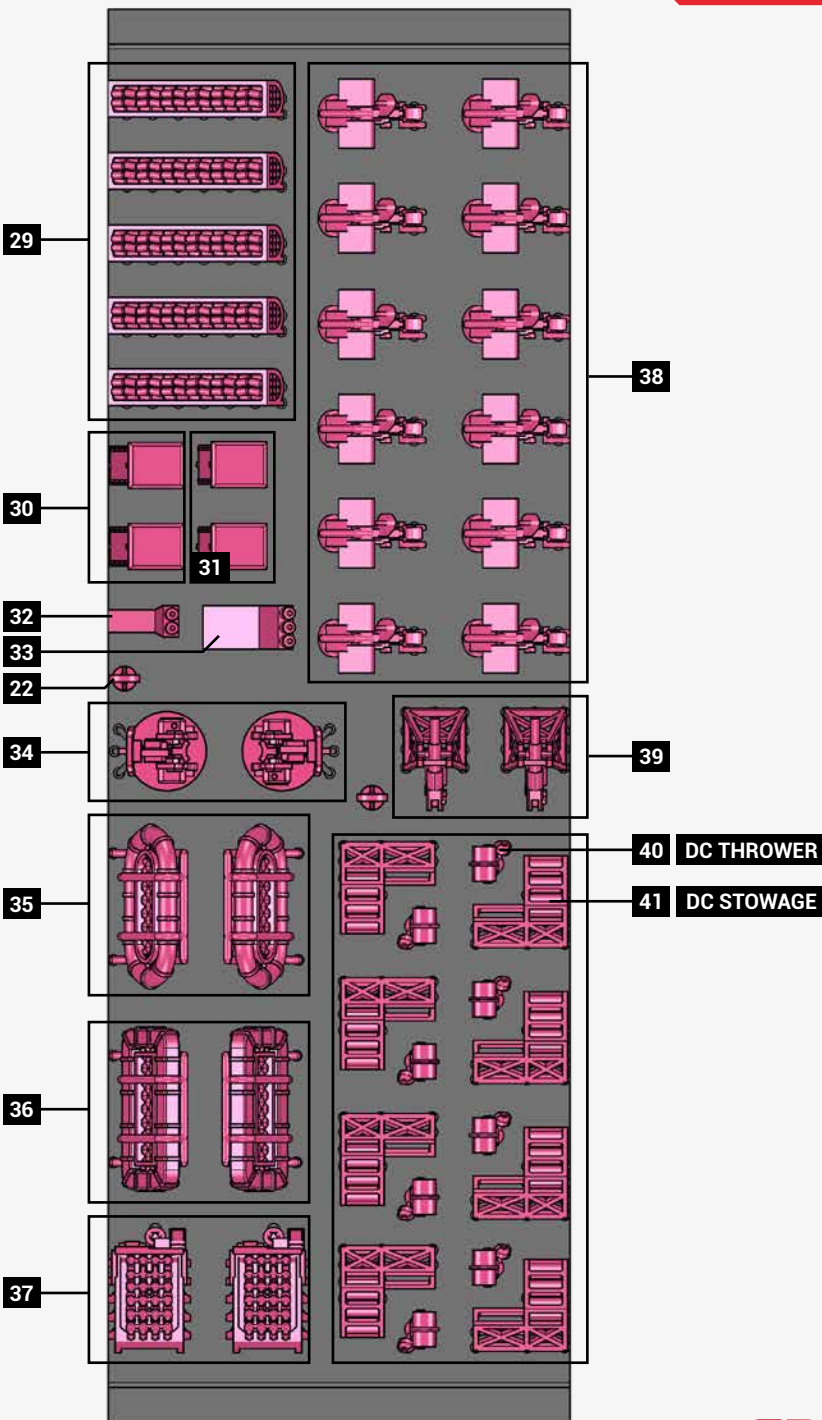

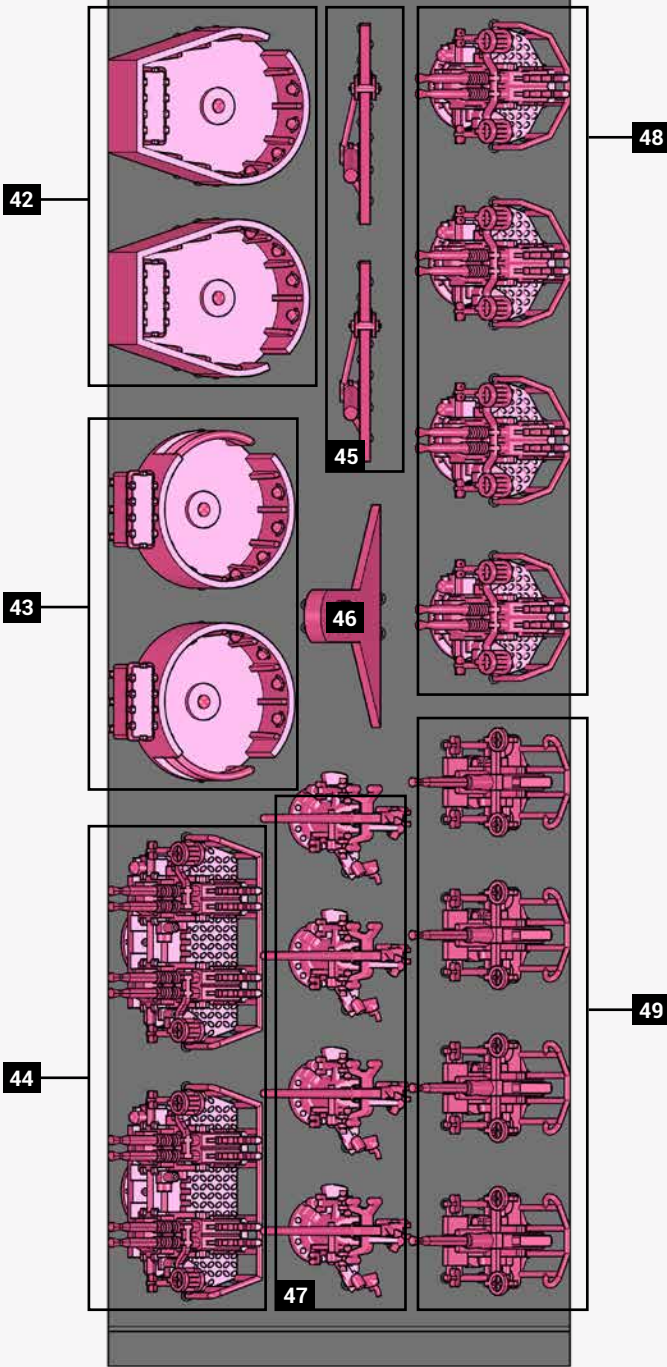

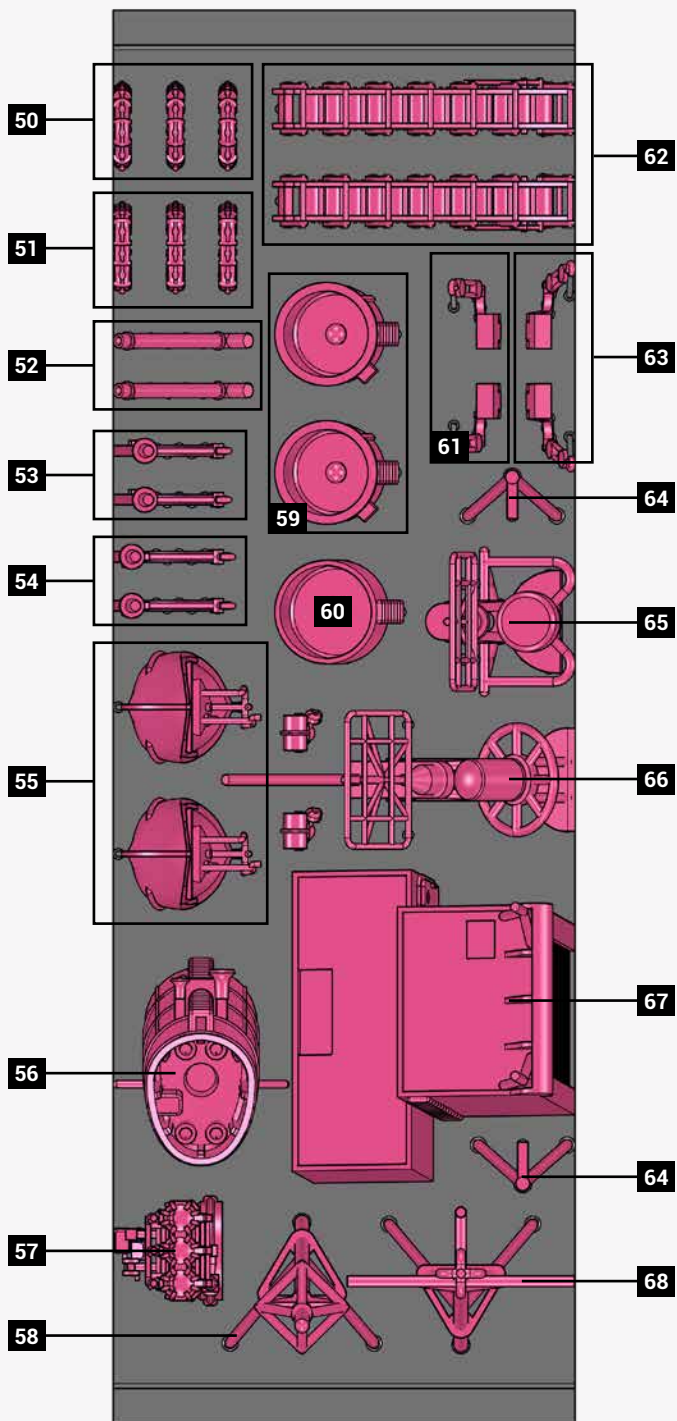

# STEP 1

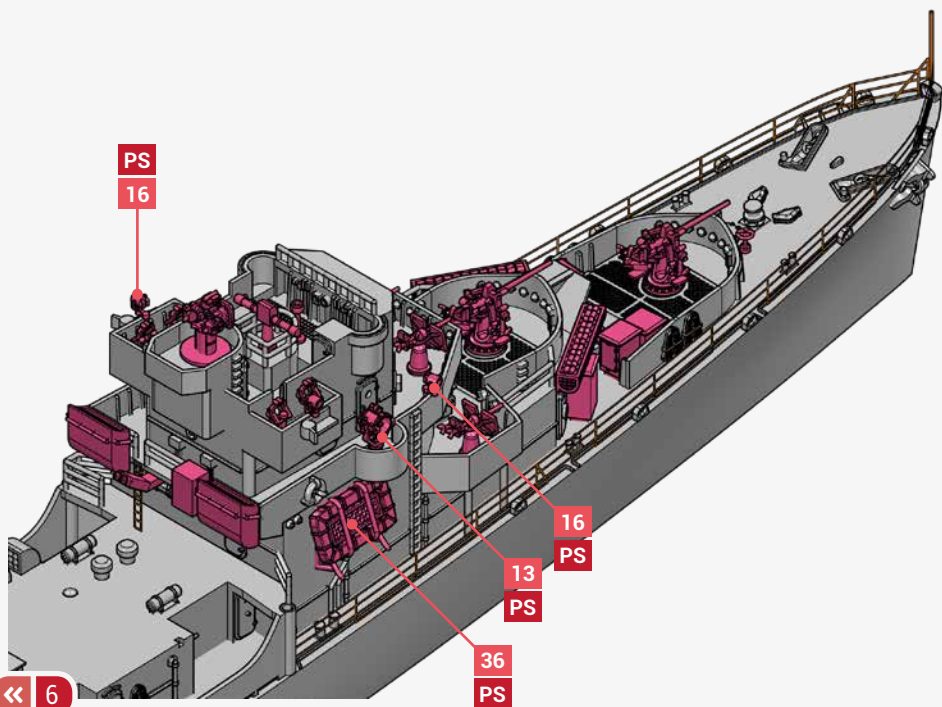
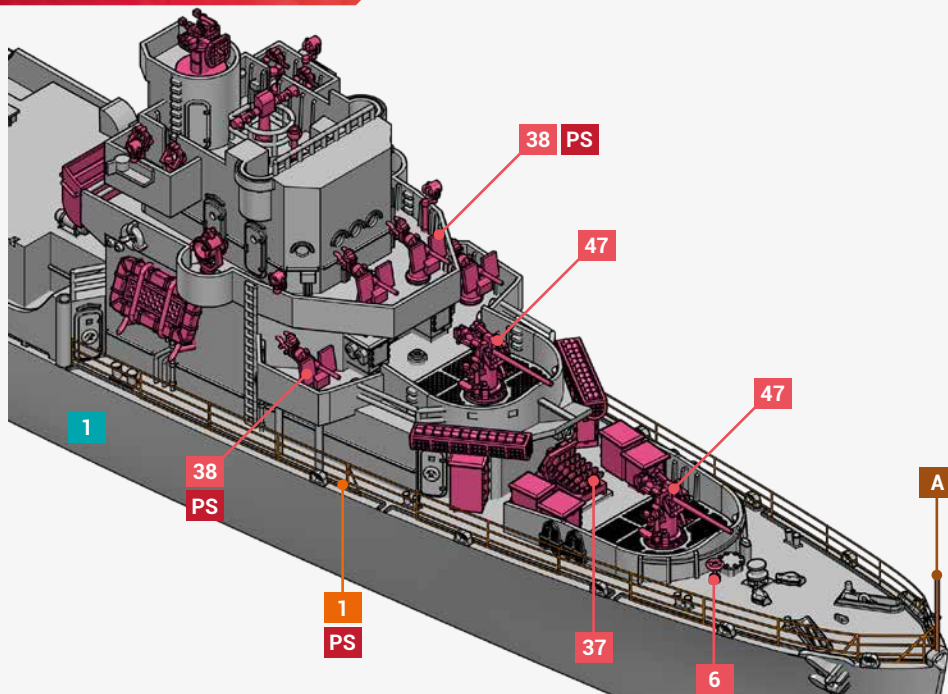

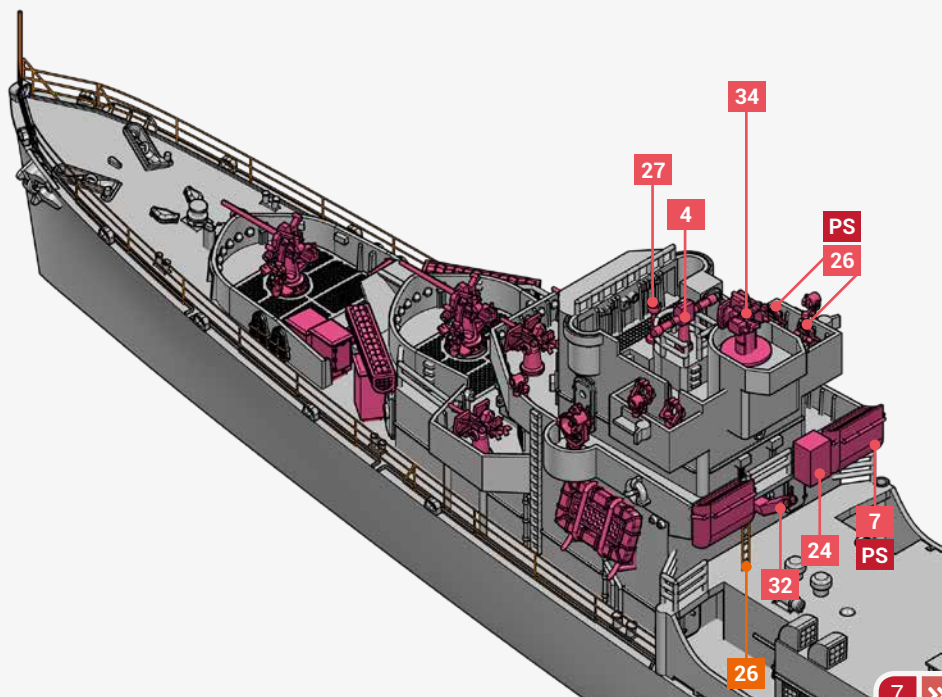
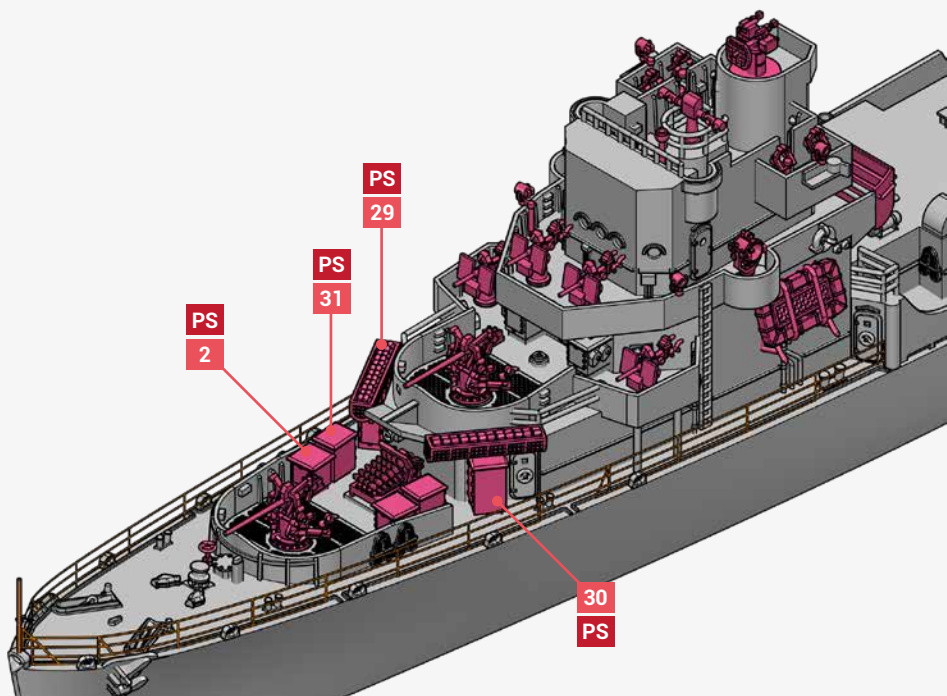

# STEP 2

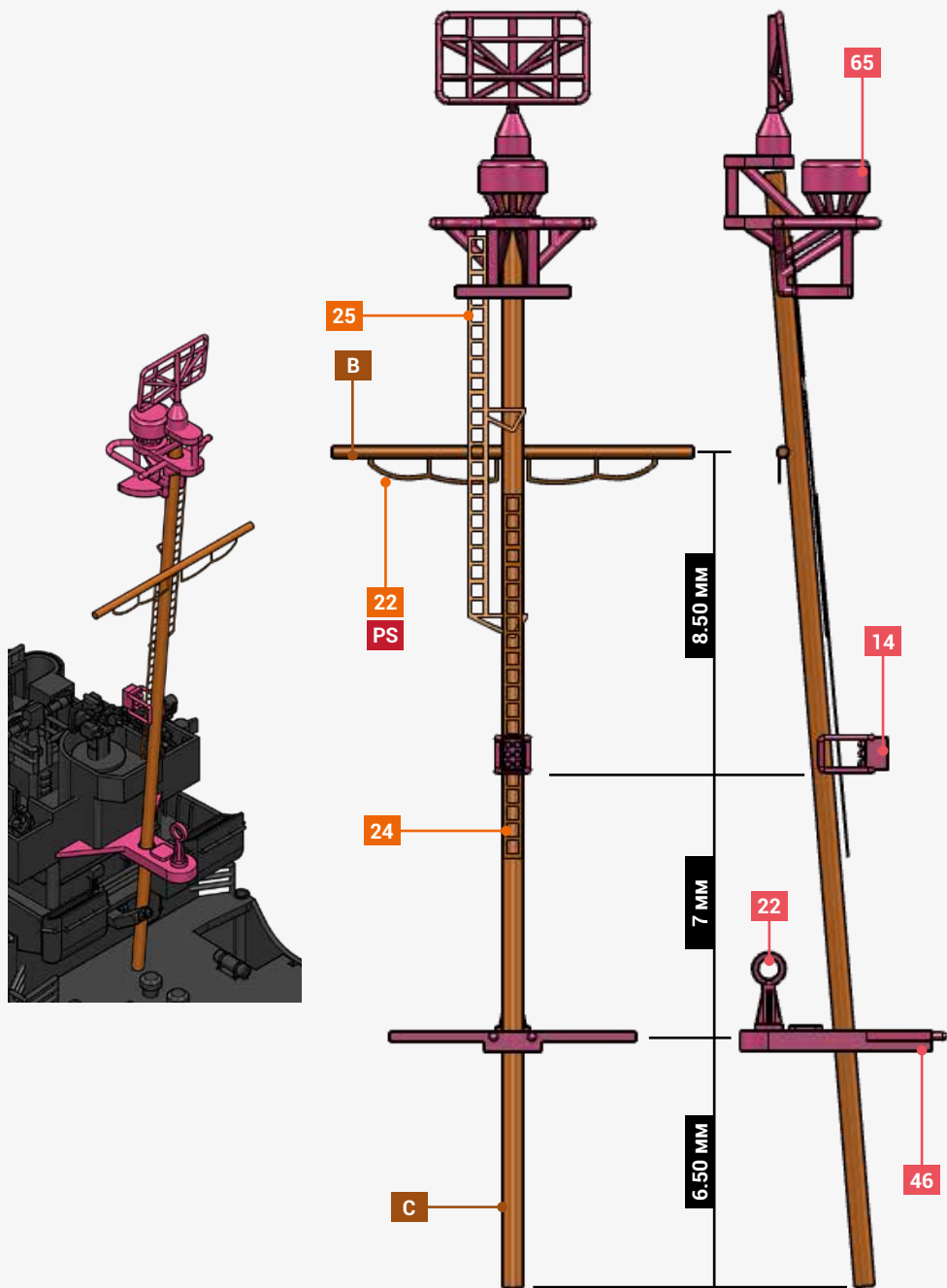

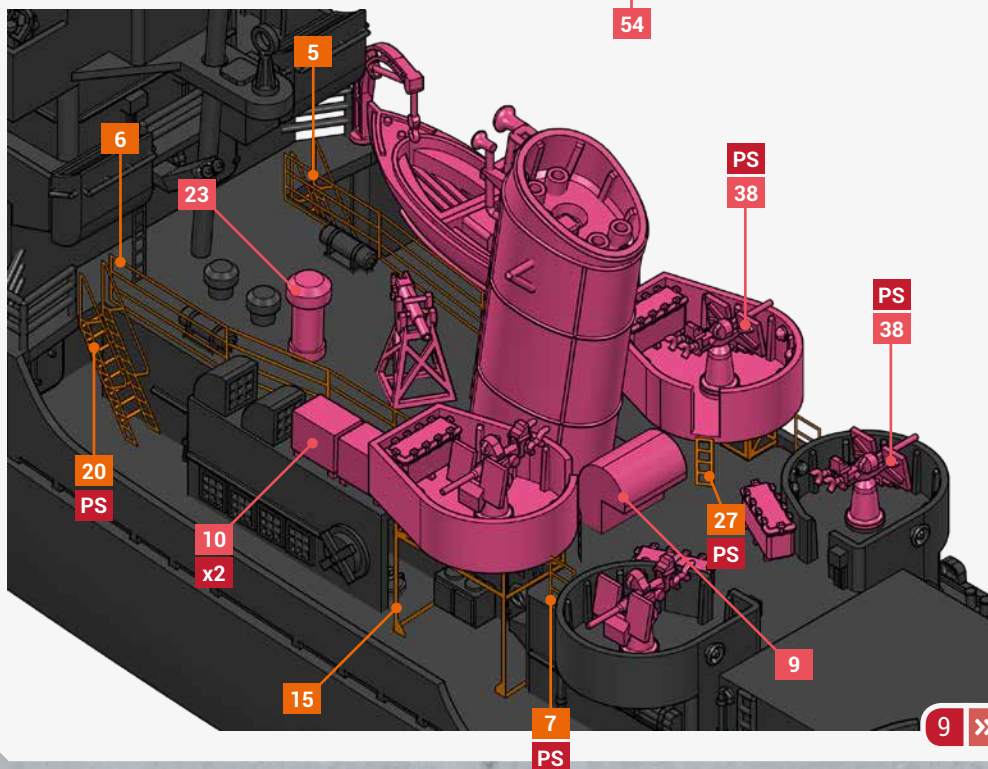
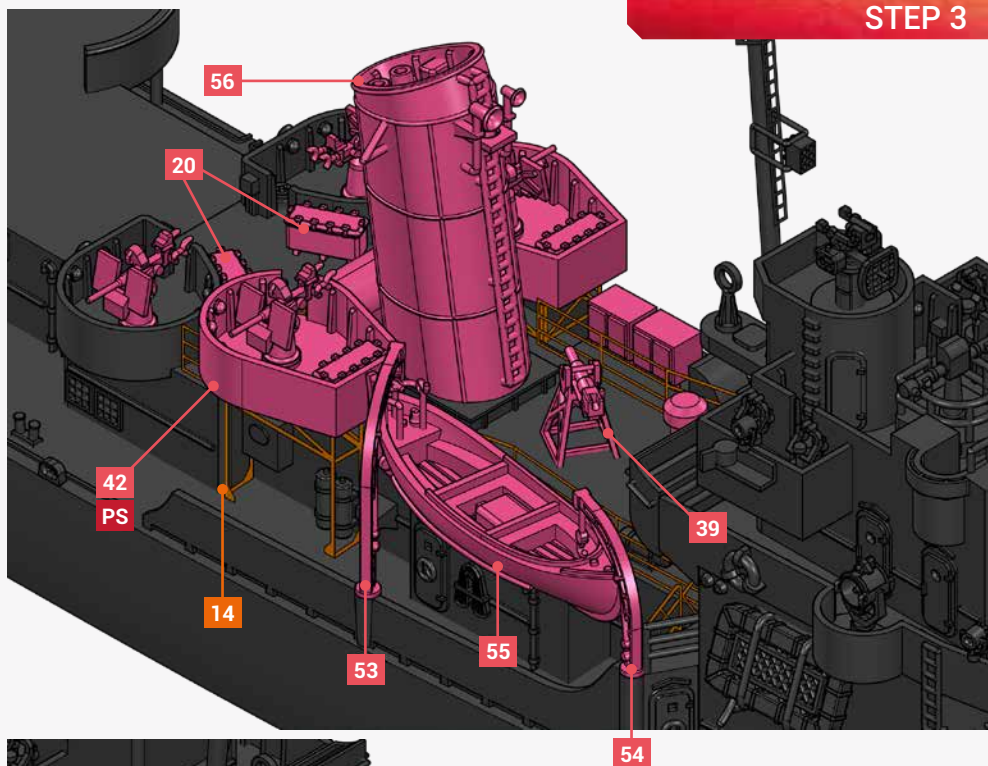

# STEP 4

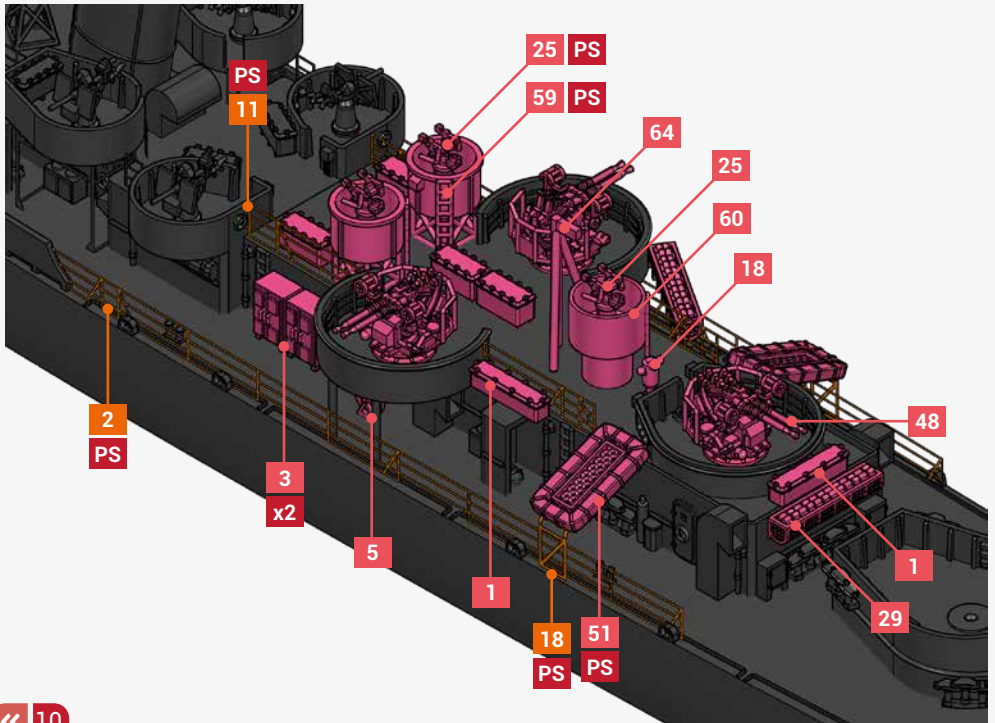
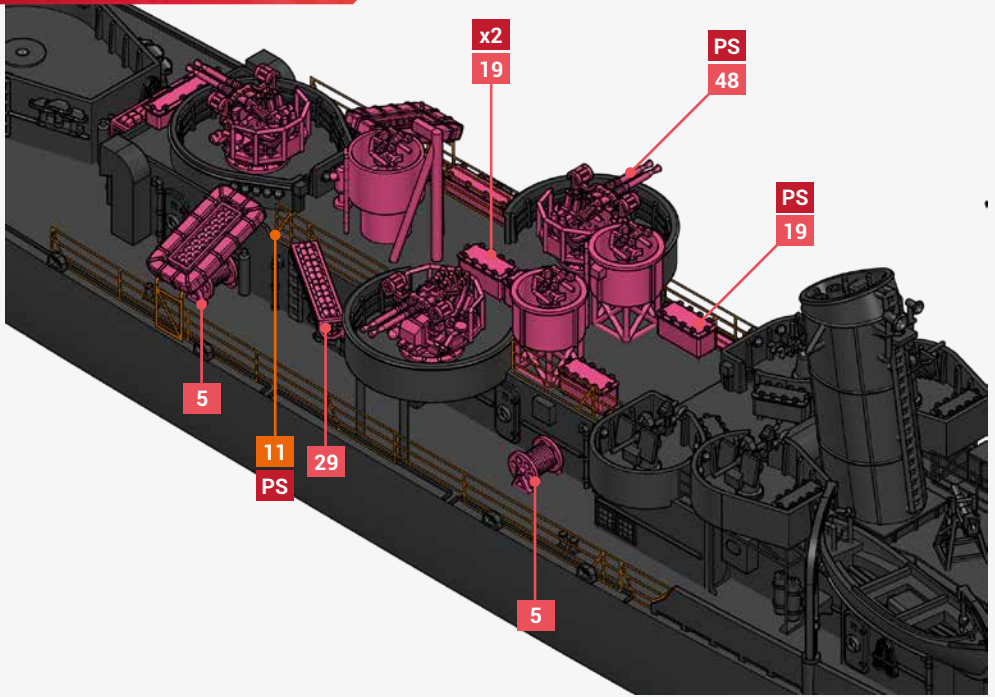

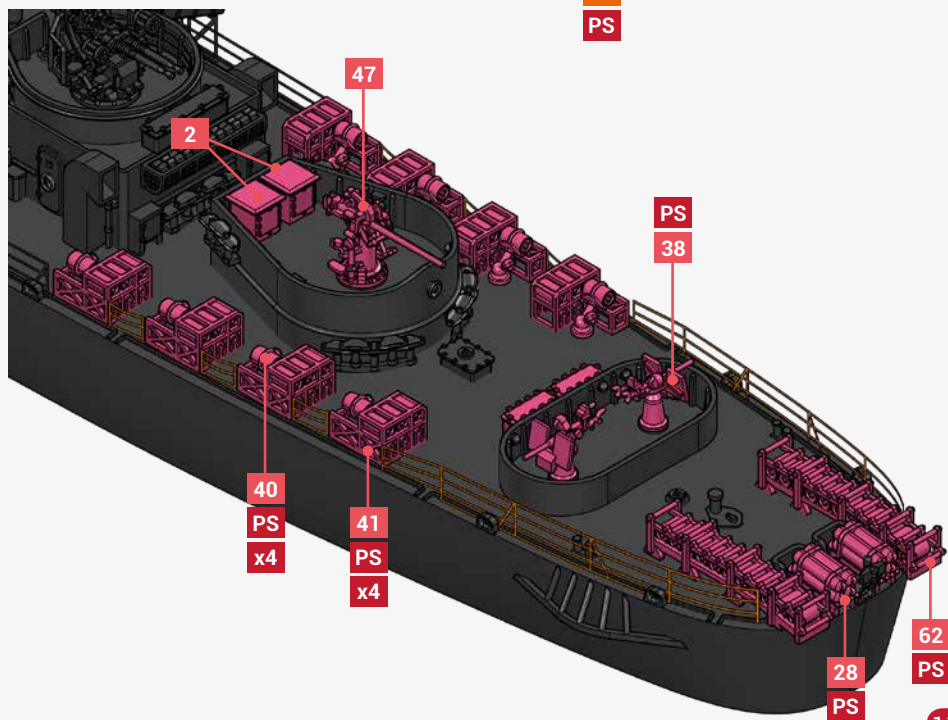
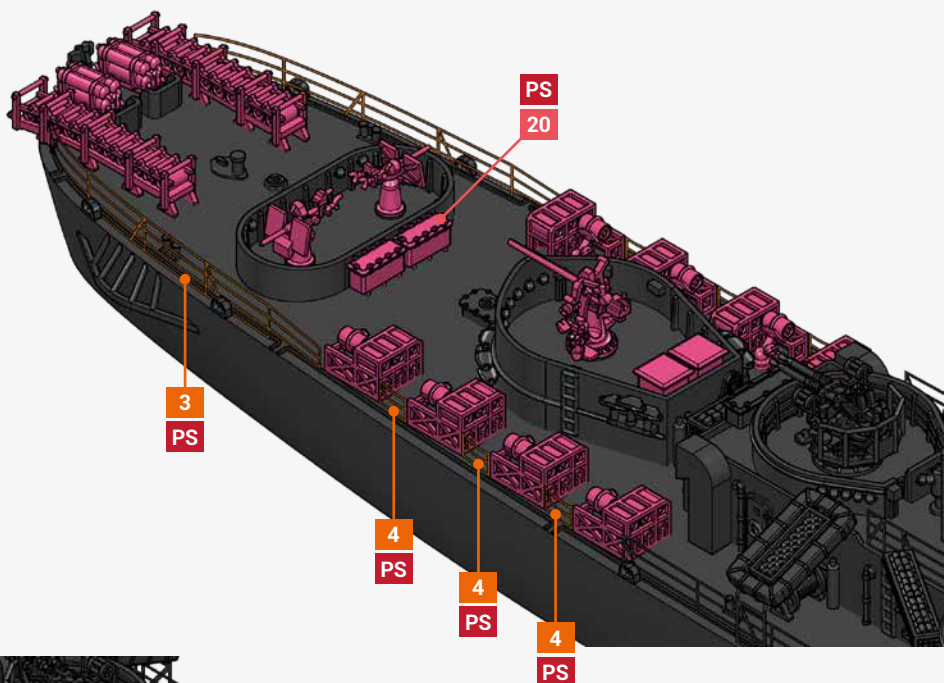

MEASURE 21 WAS USED HERE, BUT THERE ARE MANY VARIATIONS ON THE CLASS CANNON.

FOR MORE INFORMATION PLEASE VISIT :

[HTTPS://WWW.SHIPCAMOUFLAGE.COM/CANNON\\_CLASS.HTM](https://www.shipcamouflage.com/cannon_class.htm)

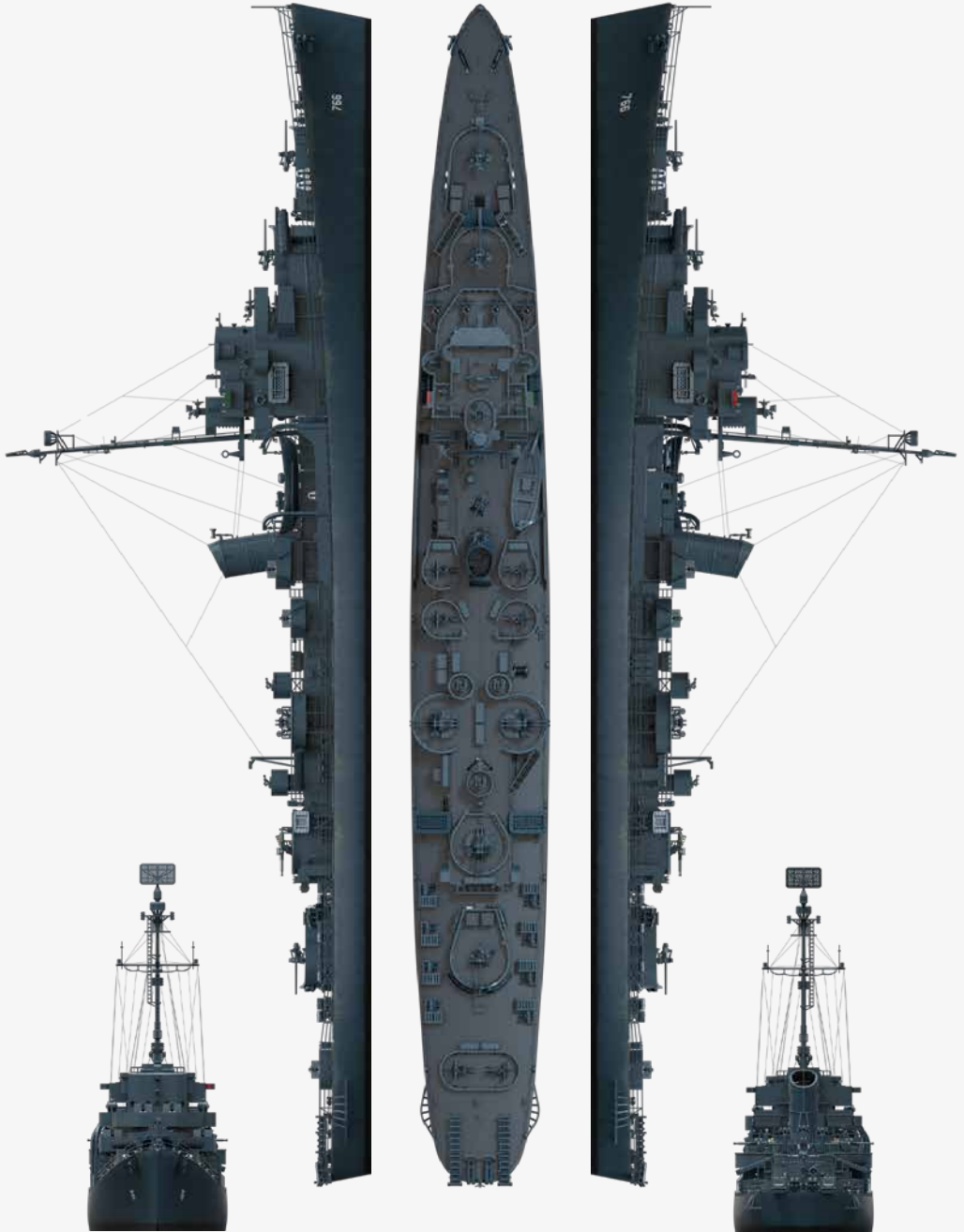

NAVY BLUE 5-N  
DECK BLUE 20-B

DECK BLUE 20-B  
BLACK