



www.blackcatmodels.eu

contact@blackcatmodels.eu

XX	RESIN PARTS
XX	3D PARTS
XX	PHOTOETCH PARTS
XX	BRASS PARTS
XX	DECALS PARTS

!	ASSEMBLY WARNING
PS	PORT & STARBOARD
P	PORT SIDE
S	STARBOARD SIDE
X	INFORMATIONS

SOME PHOTOETCH AND 3D PARTS ARE PROVIDED IN EXTRA NUMBERS.

SOME PARTS ARE PROVIDED FOR CANNON AND EDSALL KITS, MANY PARTS WON'T BE USED IN THIS BUILD.

IMPORTANT ! PLEASE FULLY READ THE INSTRUCTIONS BEFORE STARTING THE BUILD !

PHOTOETCH PARTS

DECALS

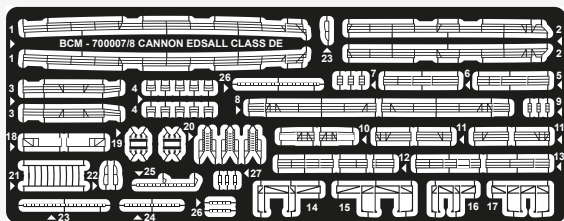

- W 422 W 422 W 422 W 422
- W 424 W 424 W 424 W 424
- W 425 W 425 W 425 W 425
- W 428 W 428 W 428 W 428
- W 431 W 431 W 431 W 431
- W 434 W 434 W 434 W 434
- W 482 W 482 W 482 W 482
- W 485 W 485 W 485 W 485
- W 487 W 487 W 487 W 487
- W 488 W 488 W 488 W 488
- W 489 W 489 W 489 W 489
- W 491 W 491 W 491 W 491

- NEWELL WDE 422 NHRZ
- FALGOUT WDE 424 NTDW
- LOWE WDE 425 NKER
- FINCH WDE 428 NTMD
- KOINER WDE 431 NHEC
- FORSTER WDE 434 NTEH
- RAMSDEN WDE 476 NTGZ
- RICHEY WDE 480 NHUS
- VANCE WDE 482 NTHE
- LANSING WDE 483 NKJ
- DURANT WDE 484 NHGJ
- CHAMBERS WDE 491 NTXV

- NHRZ NTGZ NHEC
- NTDW NHUS NTEH
- NKER NTHE NHGJ
- NTMD NKJM NTXV

BRASS PARTS

A x1 Ø=0.3mm L=4mm

B x1 Ø=0.3mm L=9mm

C x1 Ø=0.5mm L=29mm

PARTS

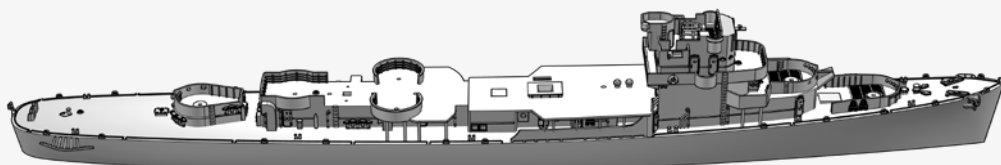

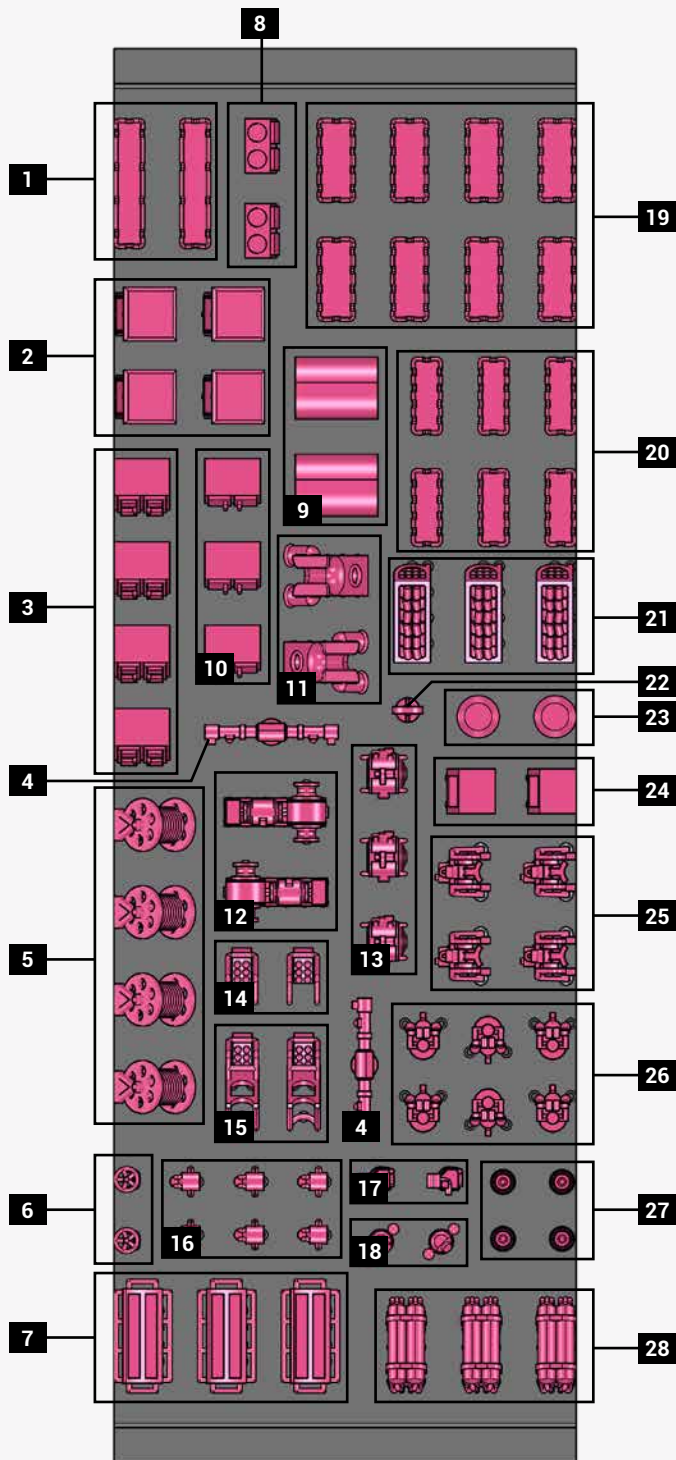

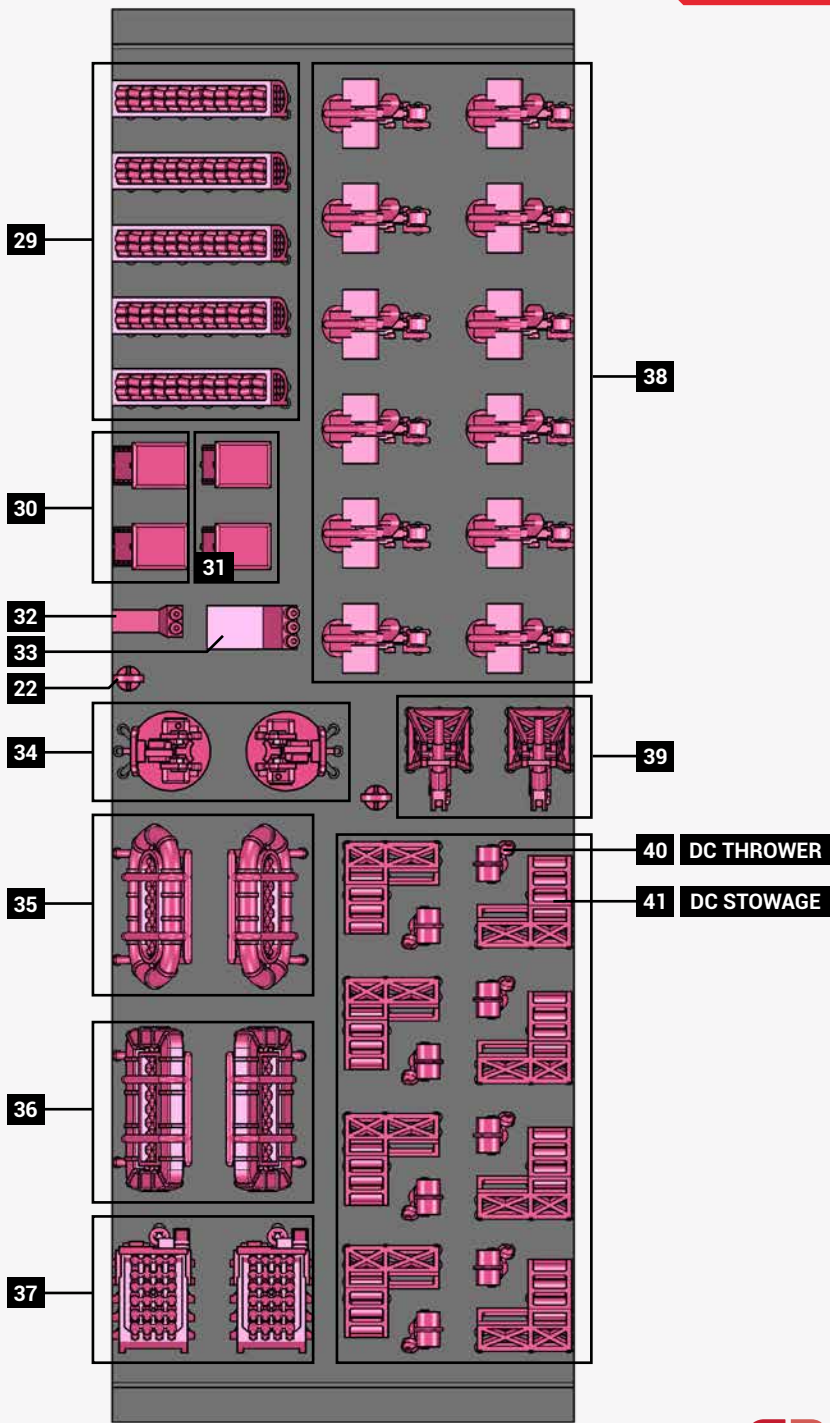

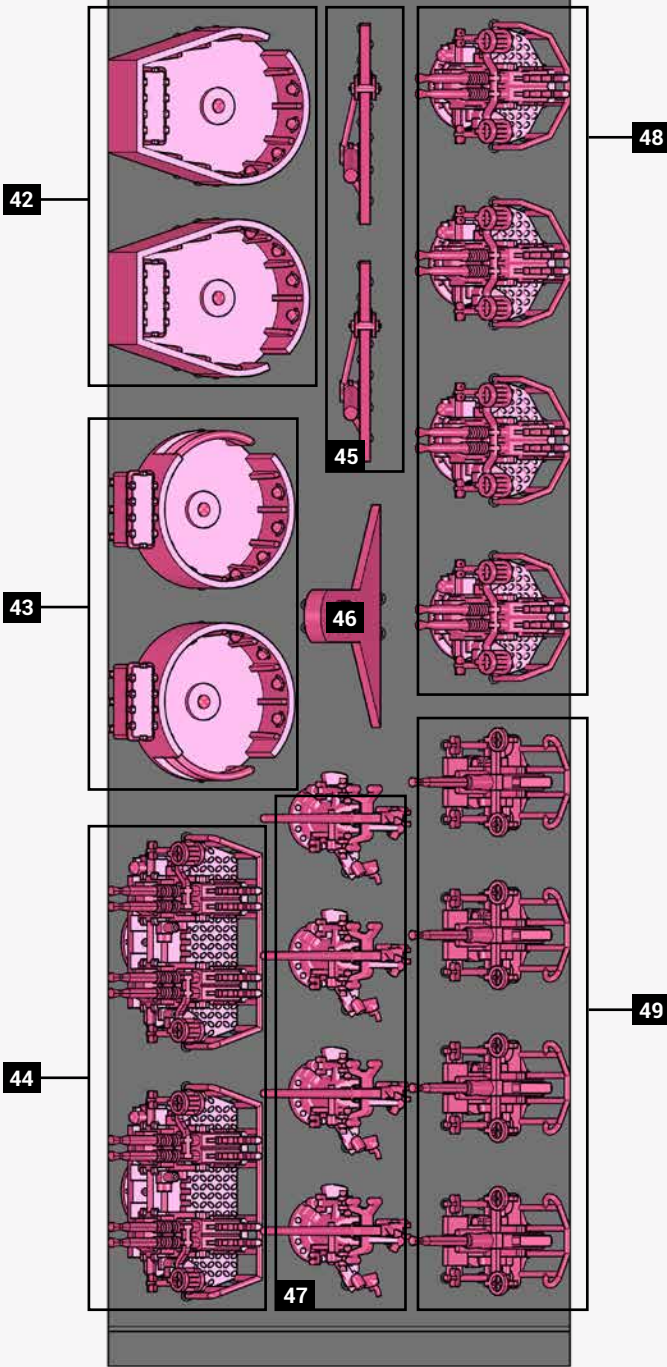

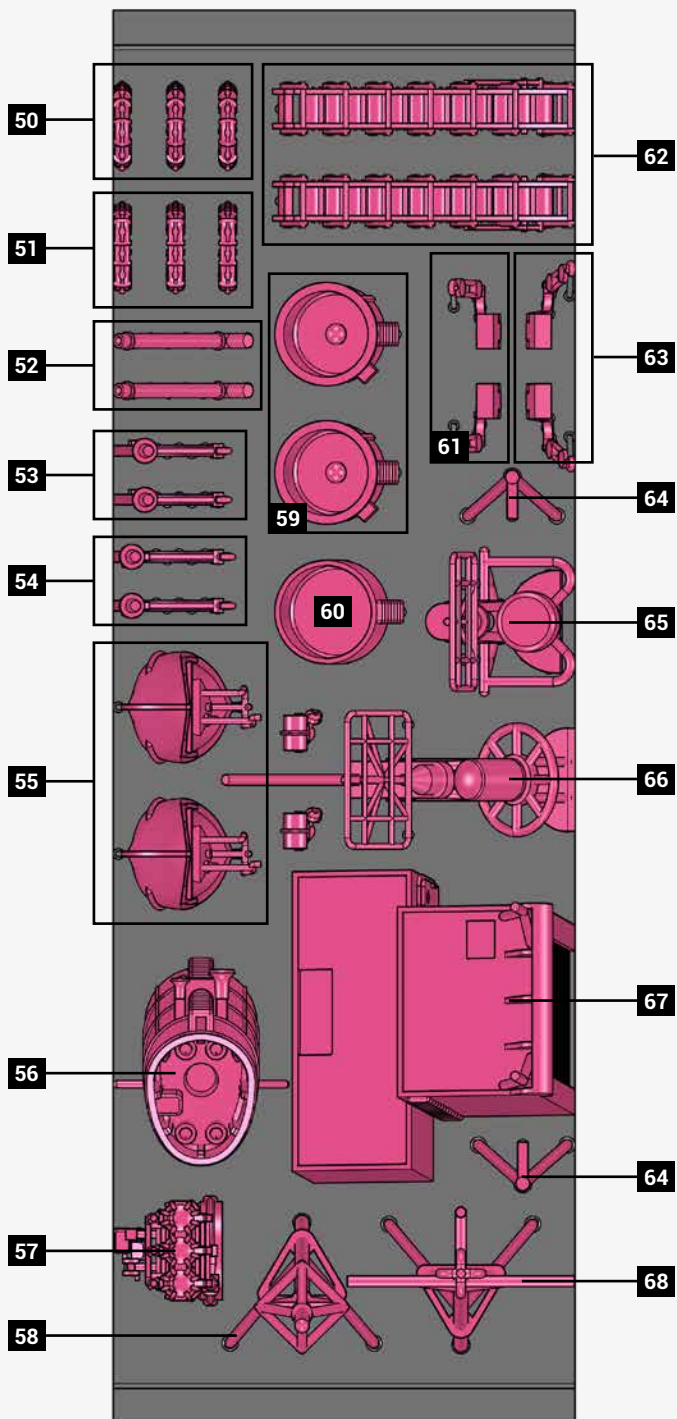

STEP 1

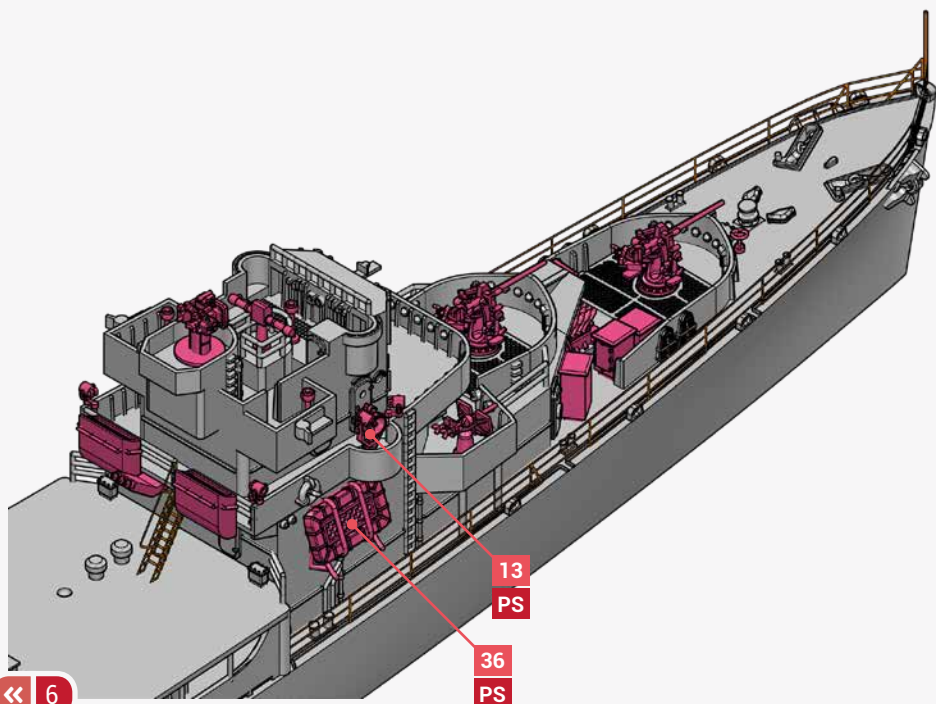
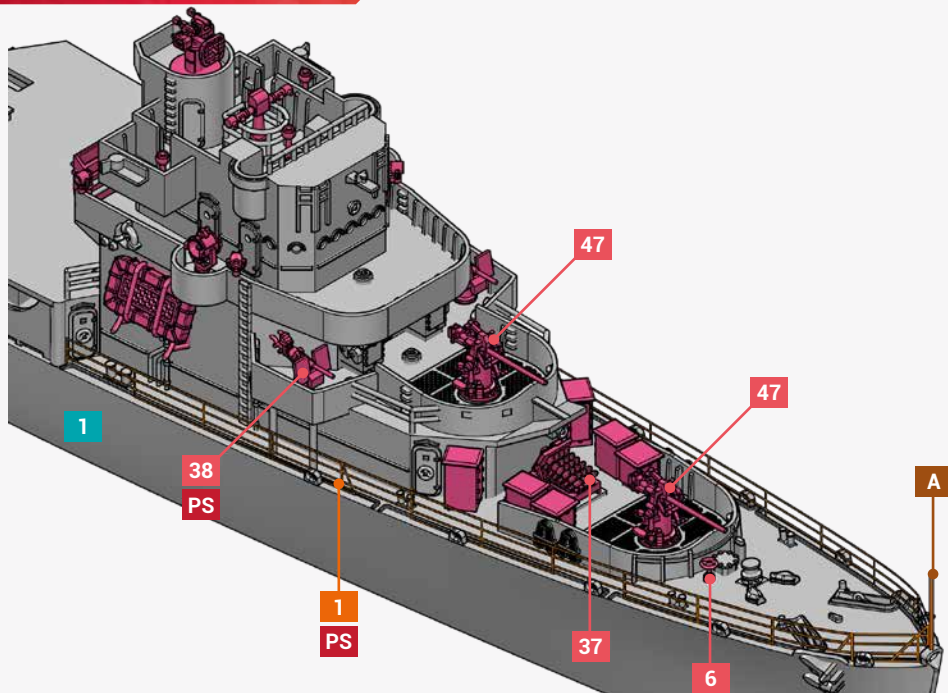

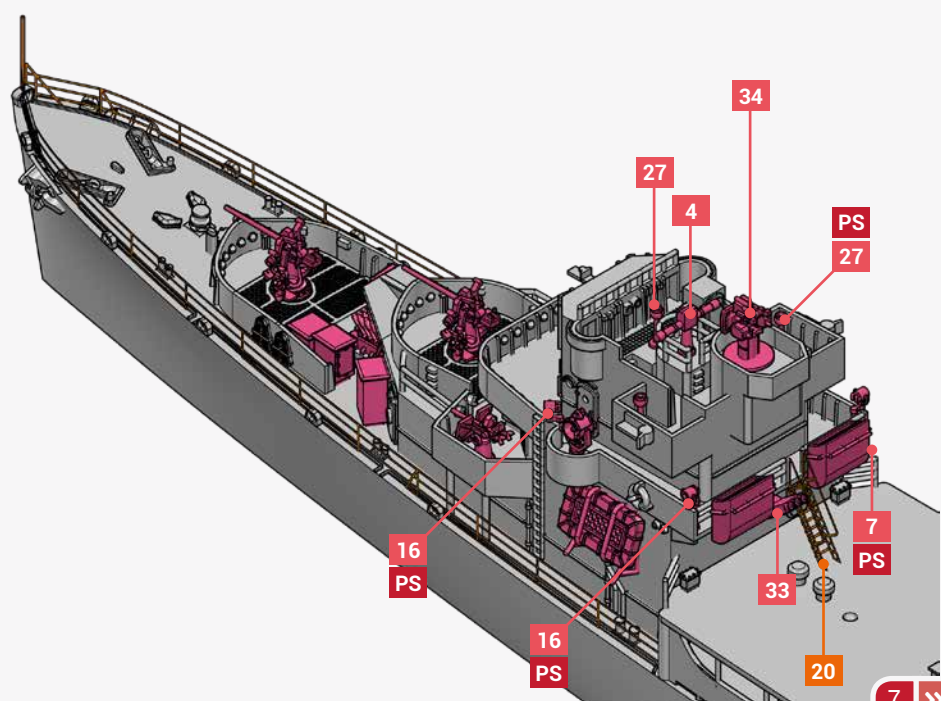
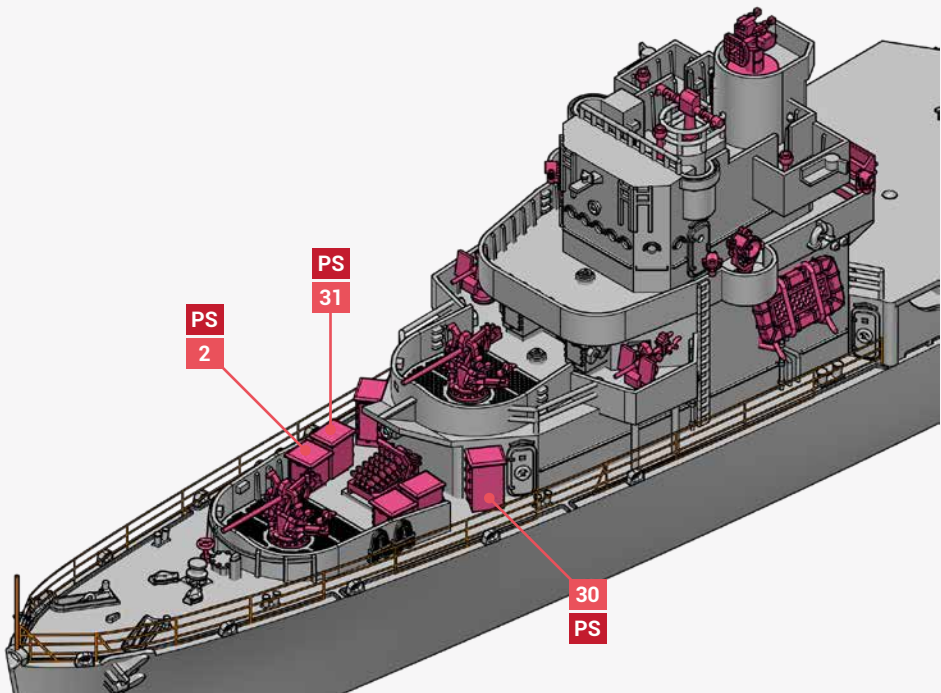

STEP 2

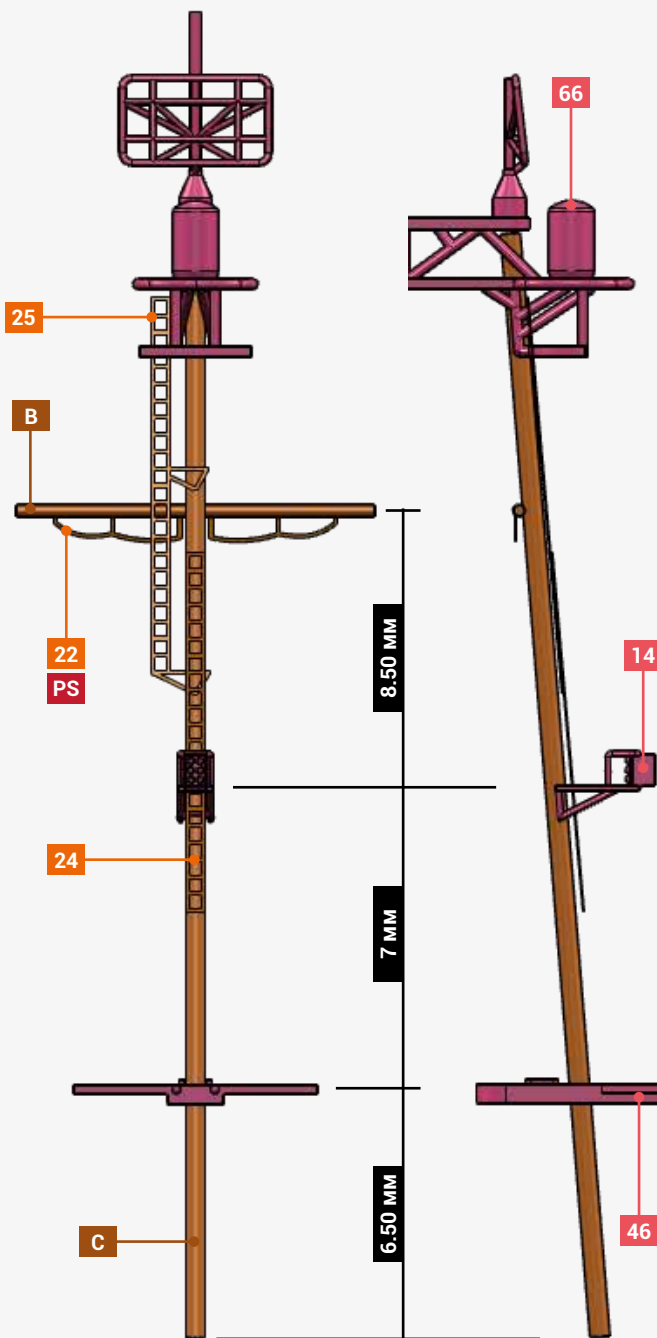
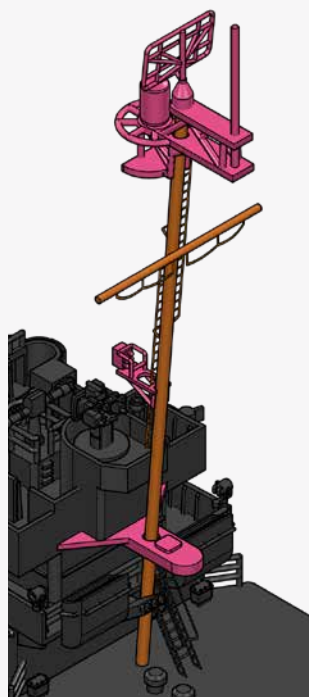

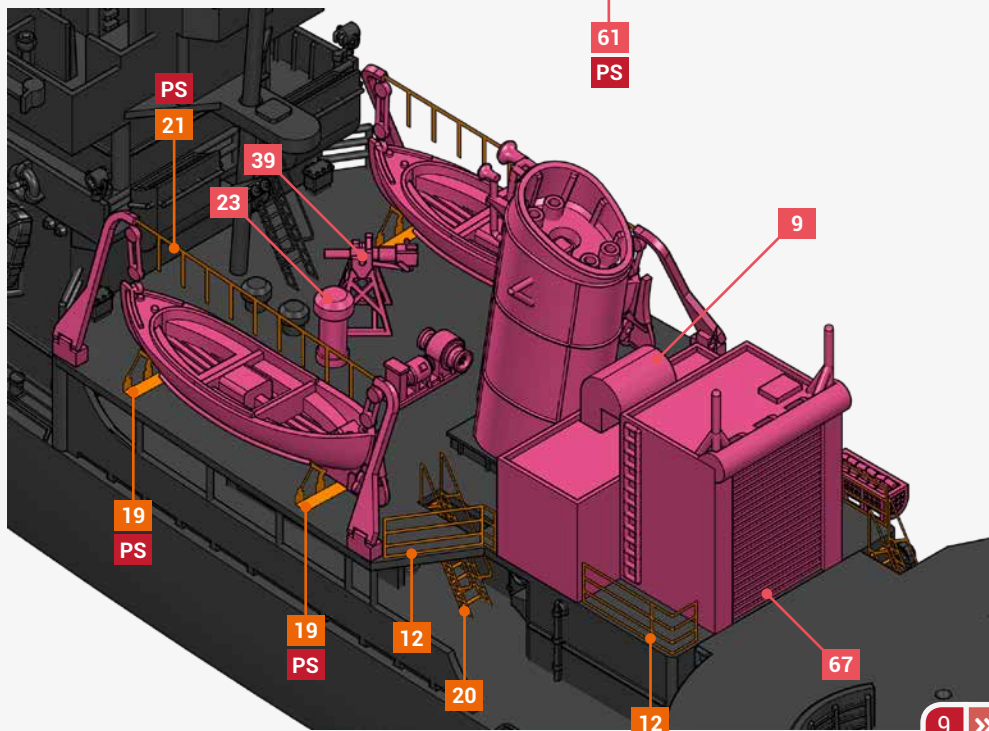
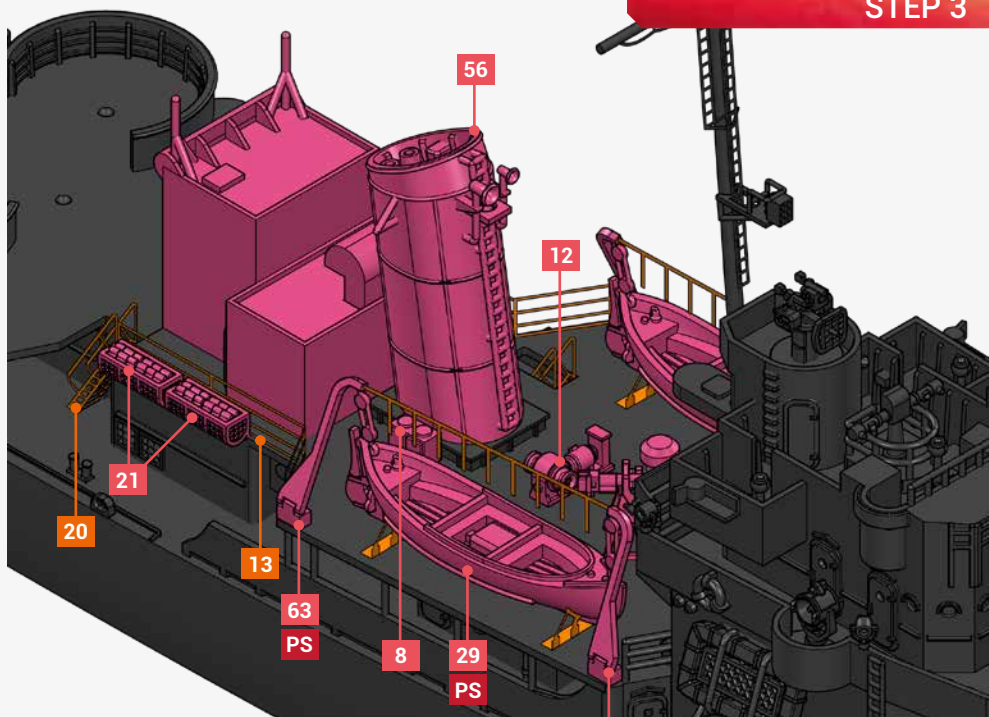

STEP 4

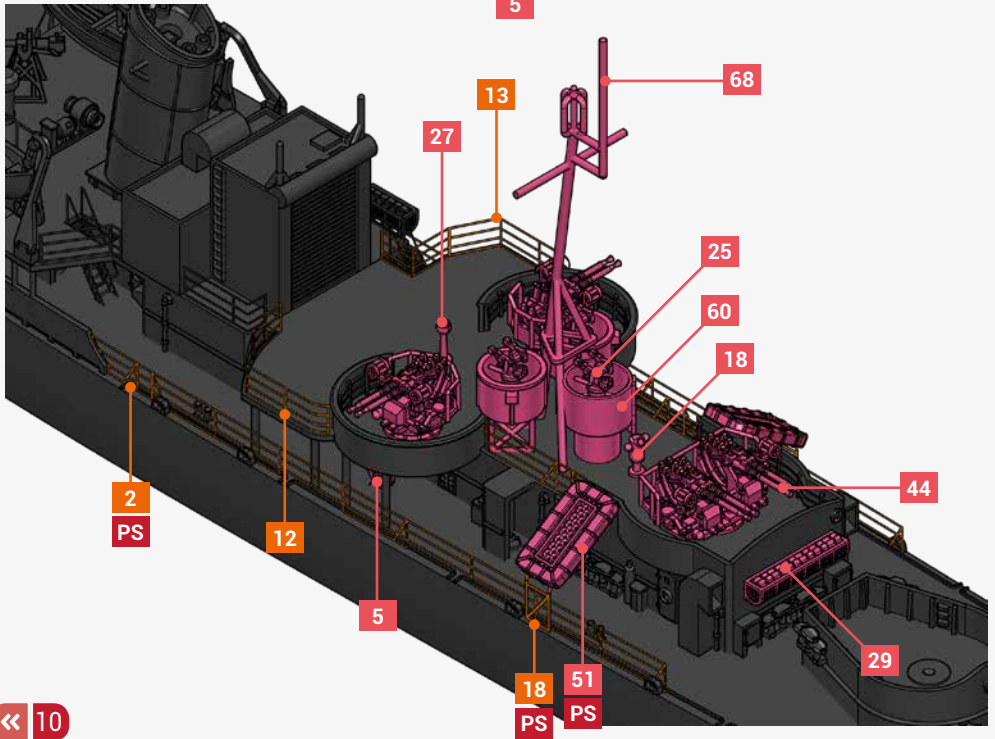
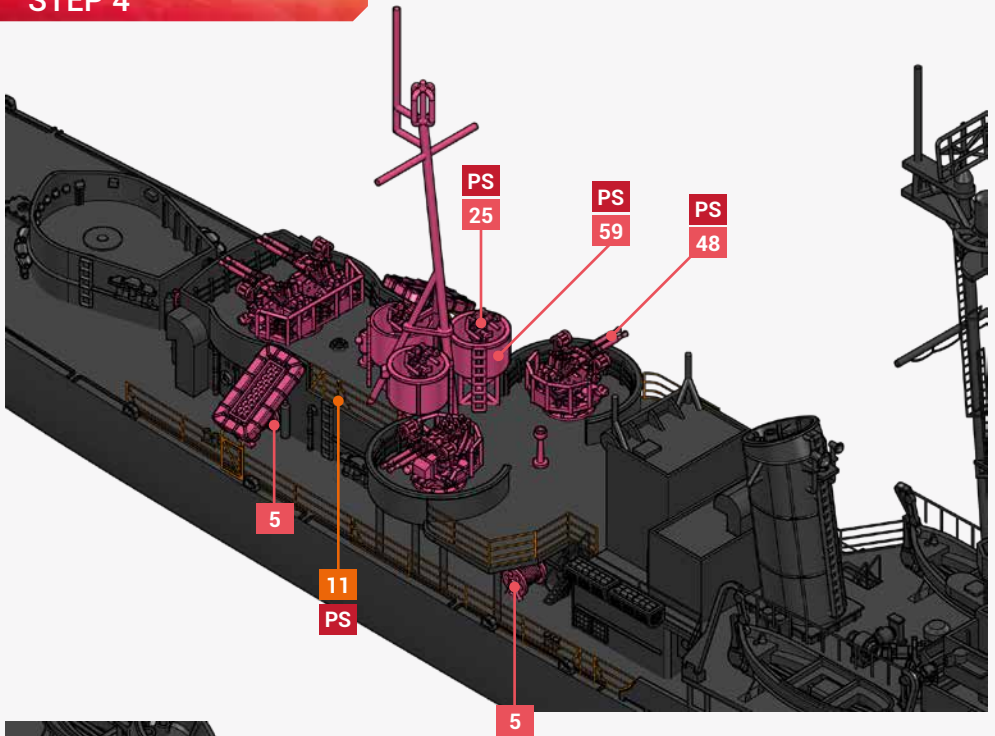

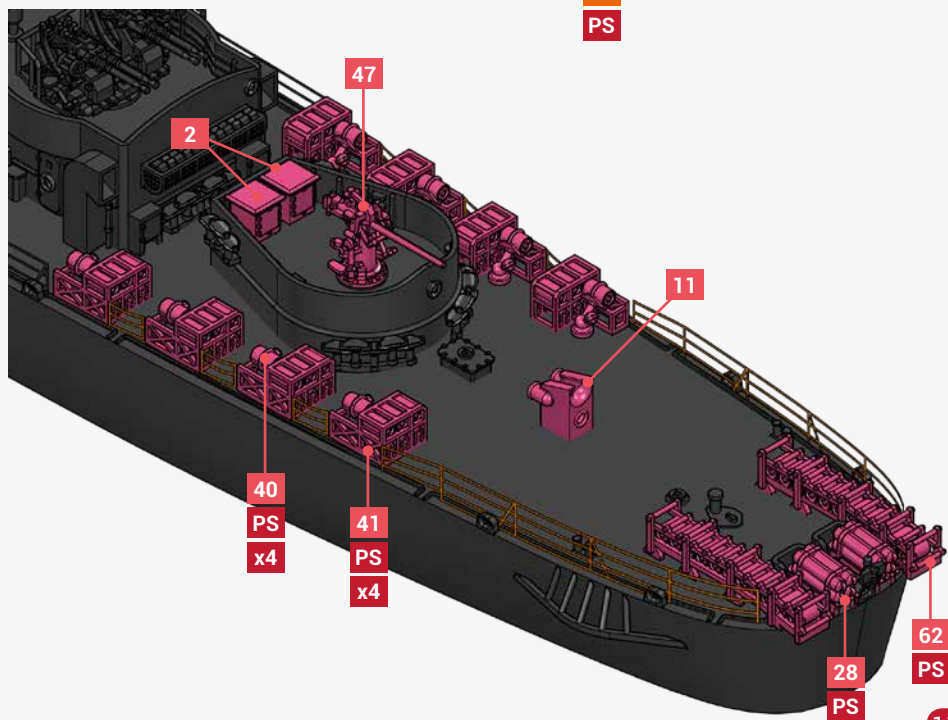
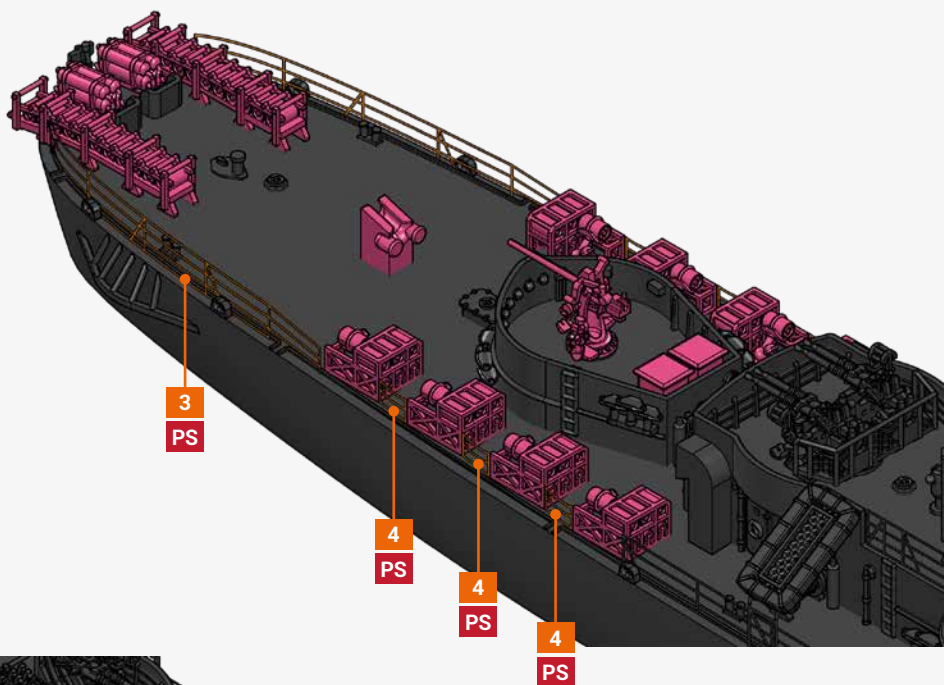

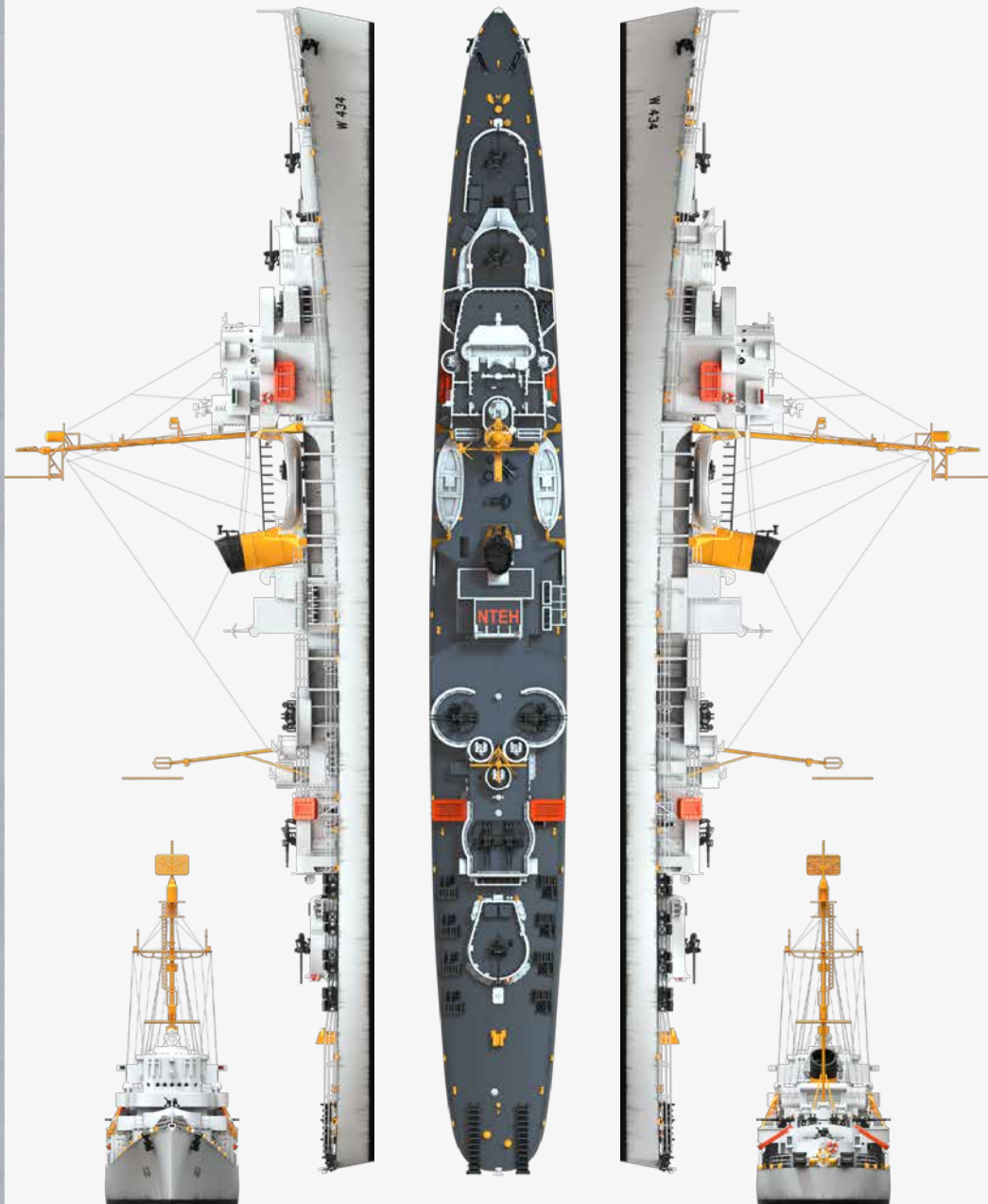

WHITE
 YELLOW

BLACK
 DECK BLUE 20-B