



USCG BERTHOLF WMSL-750



700 009

1/700°



www.blackcatmodels.eu

contact@blackcatmodels.eu

XX	RESIN PARTS
XX	3D PARTS
XX	PHOTOETCH PARTS
XX	BRASS PARTS
XX	DECALS PARTS

!	ASSEMBLY WARNING
PS	PORT & STARBOARD
P	PORT SIDE
S	STARBOARD SIDE
X	INFORMATIONS

SOME PHOTOETCH AND 3D PARTS CAN BE PROVIDED IN EXTRA NUMBERS.

IMPORTANT ! PLEASE FULLY READ THE INSTRUCTIONS BEFORE STARTING THE BUILD !

PHOTOETCH PARTS

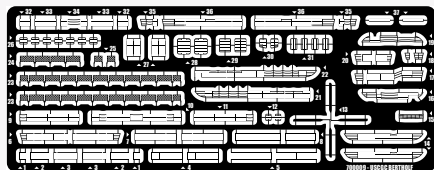

DECALS

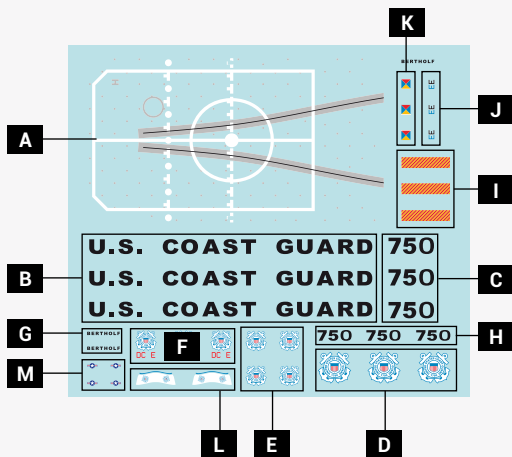

BRASS PARTS

A x4 Ø=0.3MM L=15MM

3D PARTS

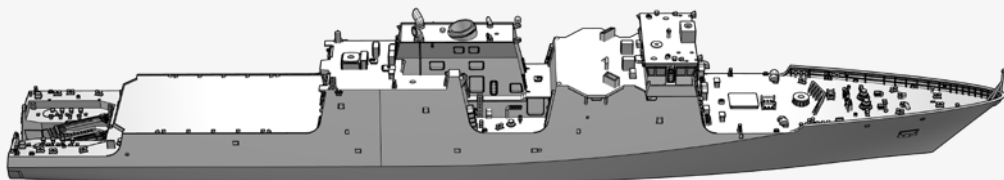

1

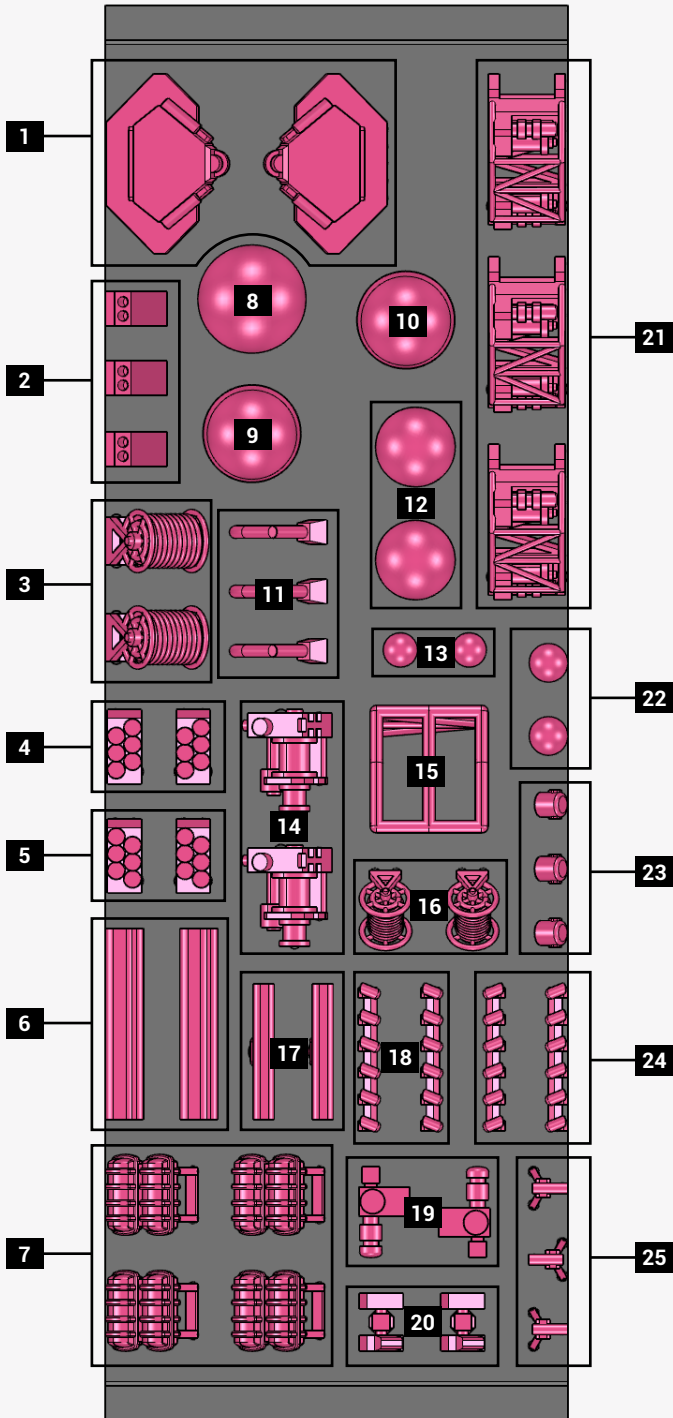

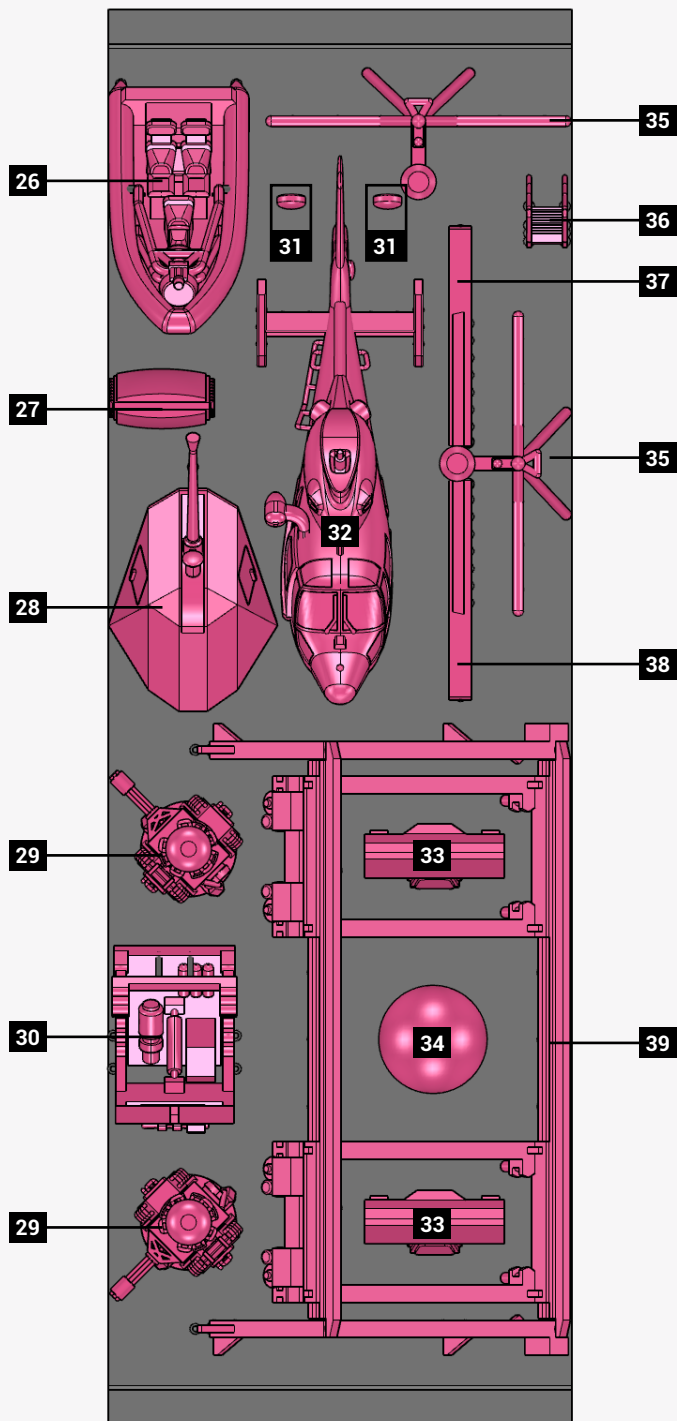

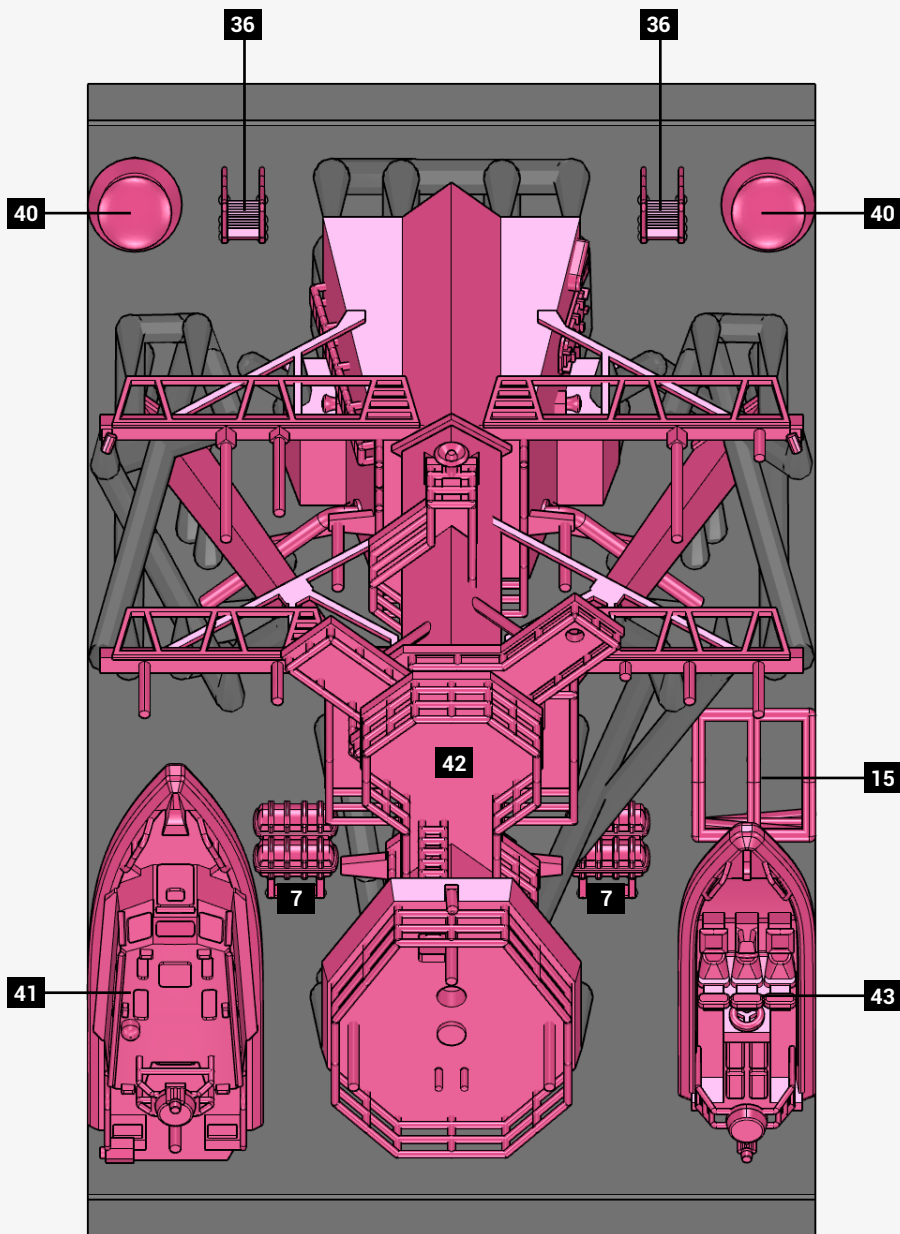

STEP 1

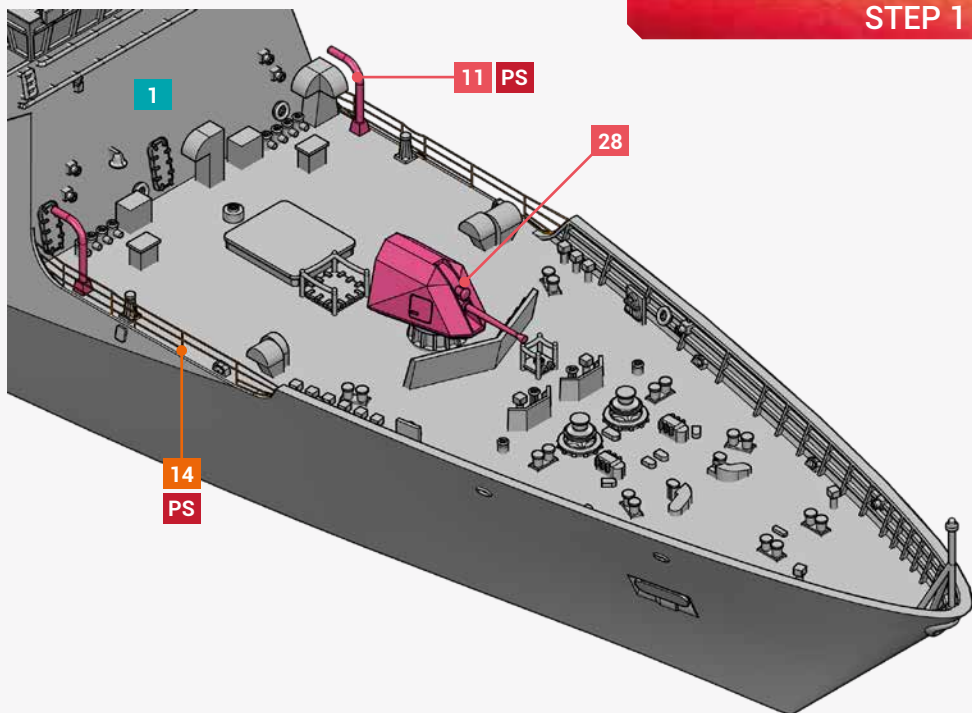

STEP 2

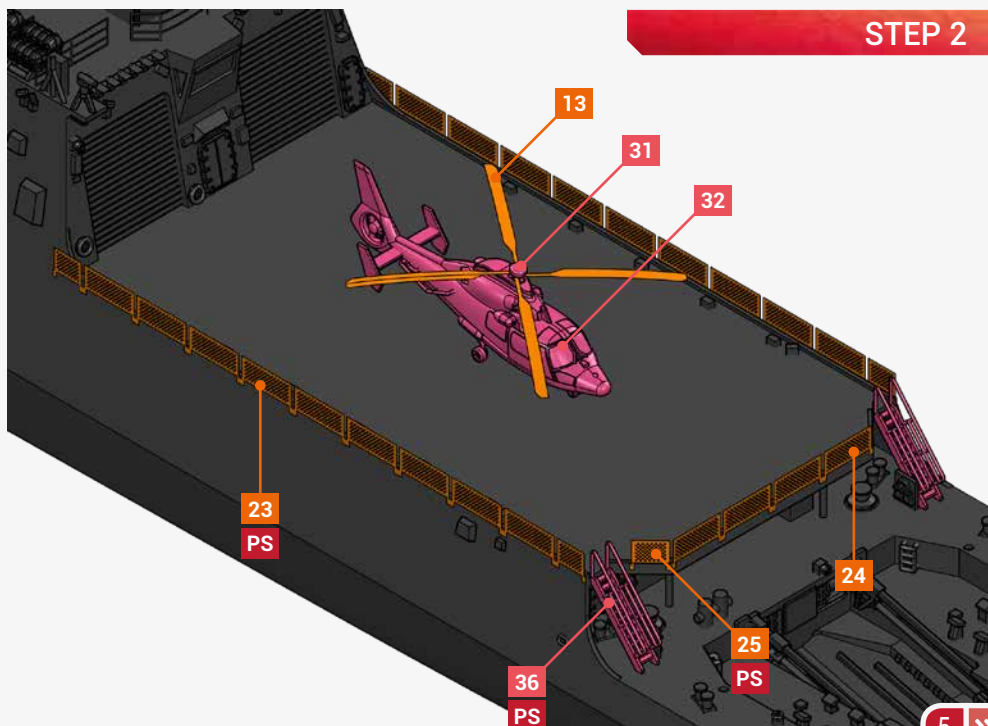

STEP 3

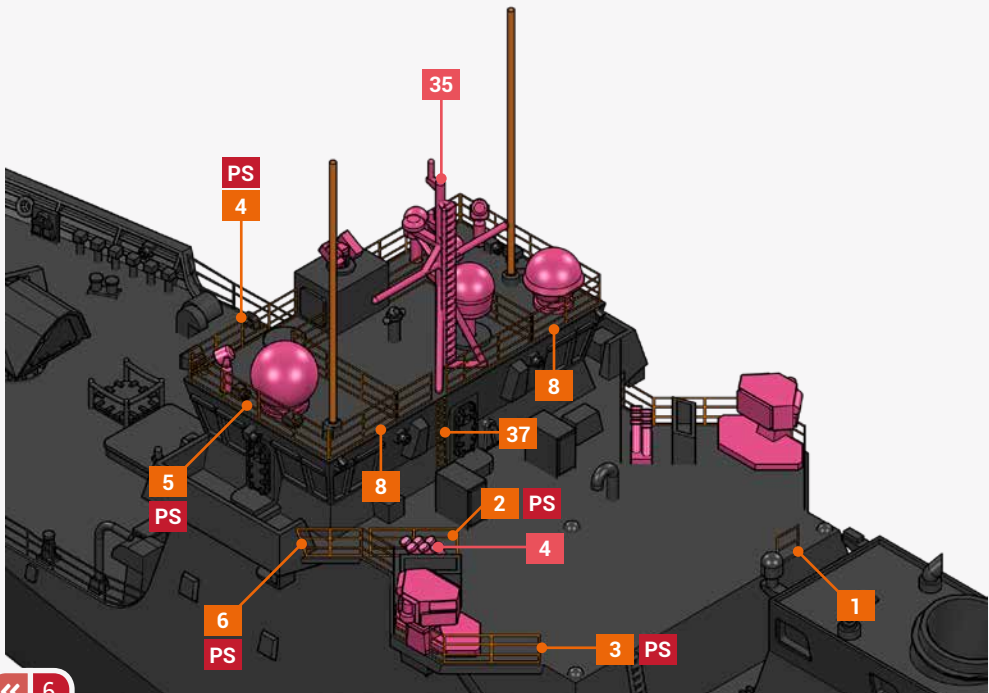
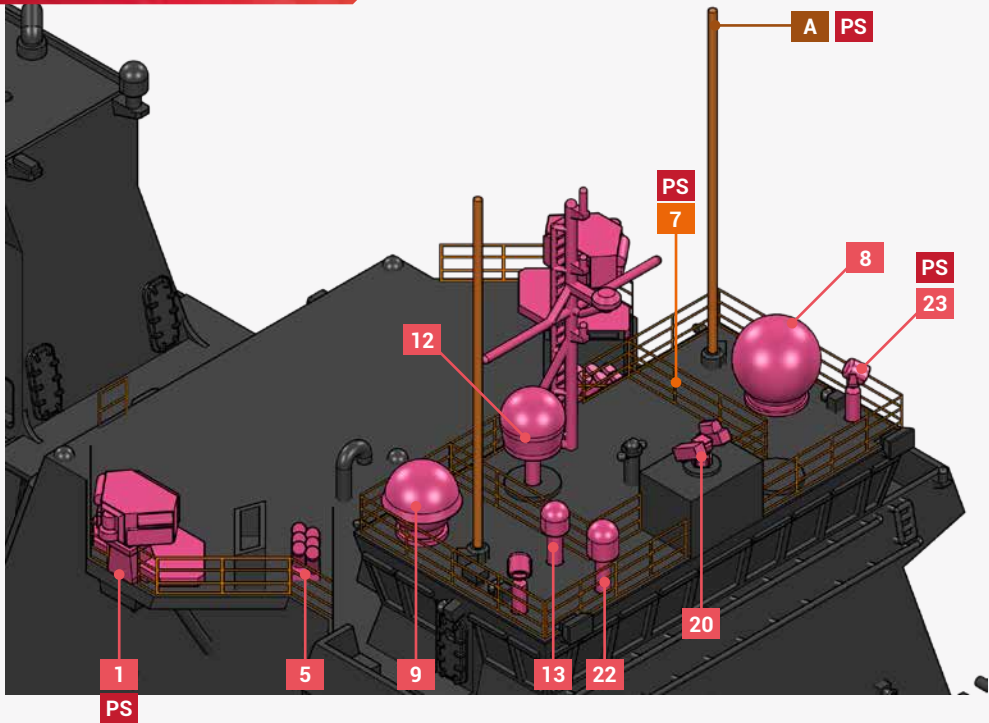

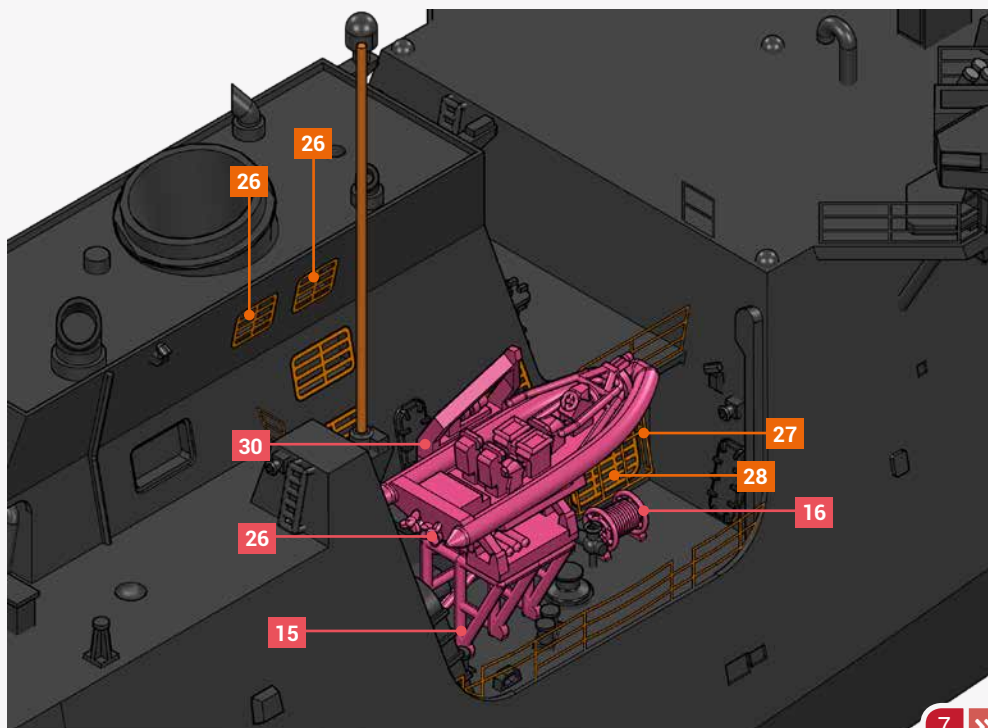
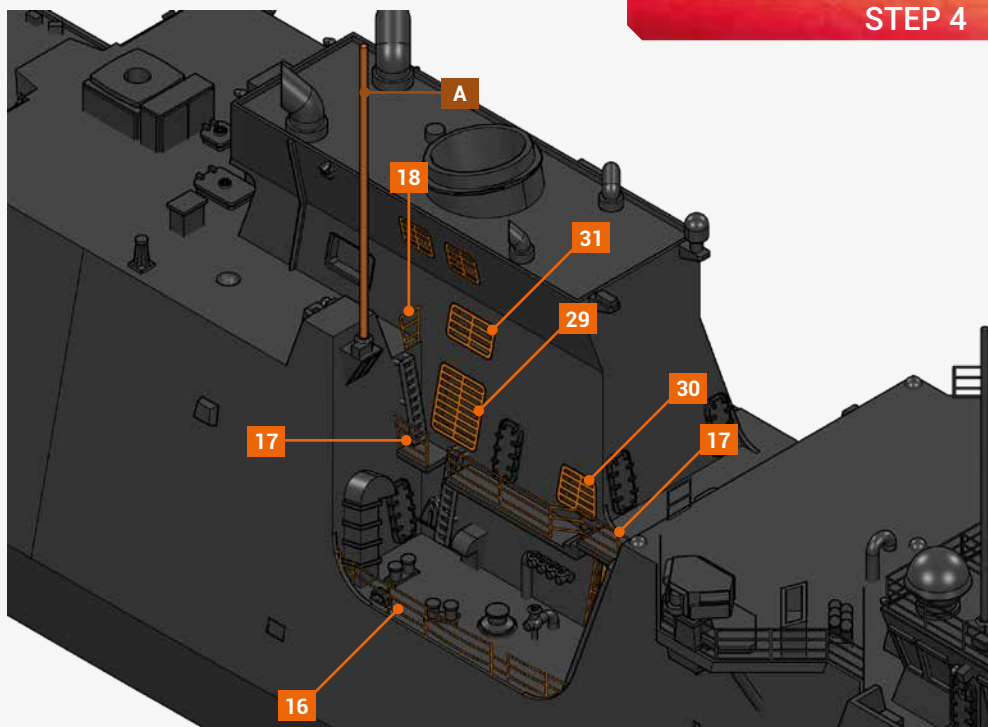

STEP 5

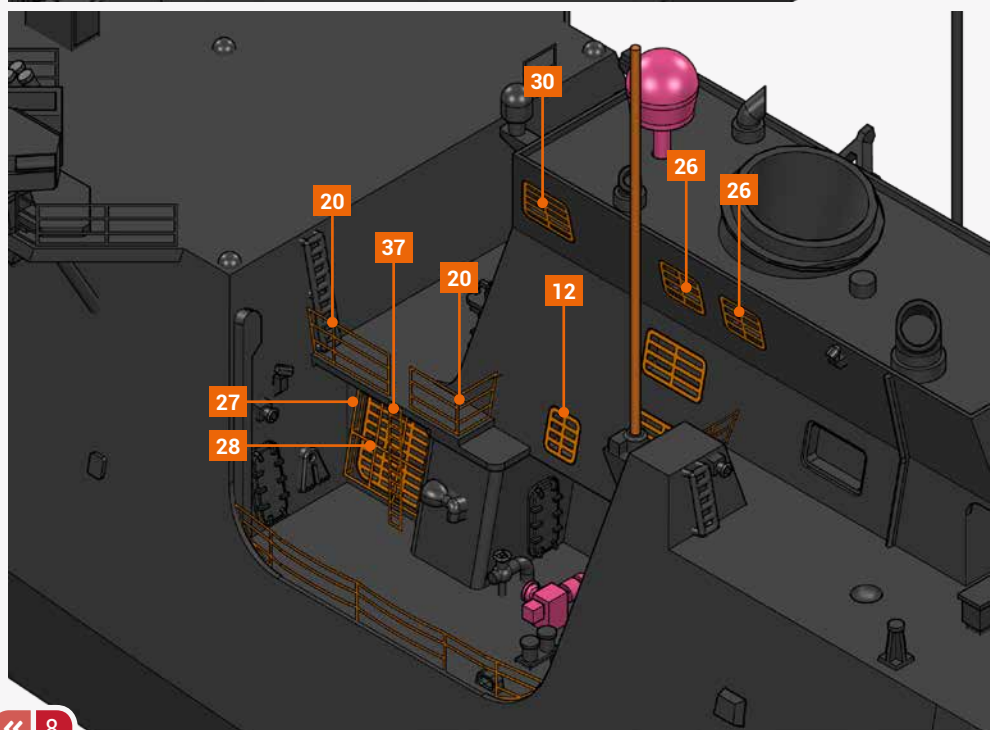
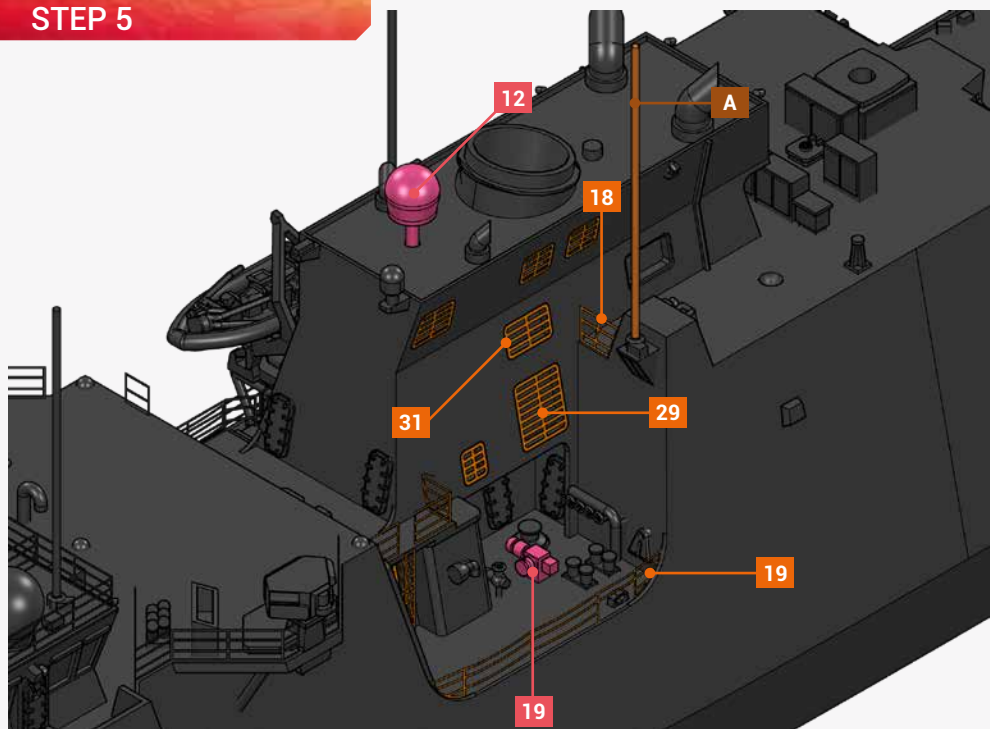

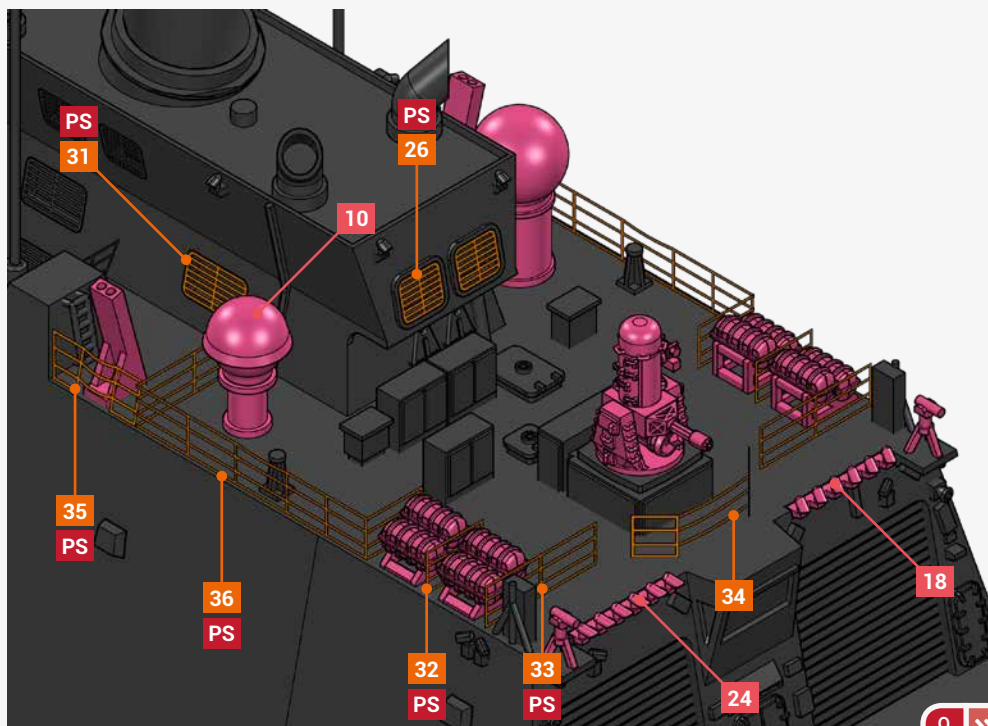
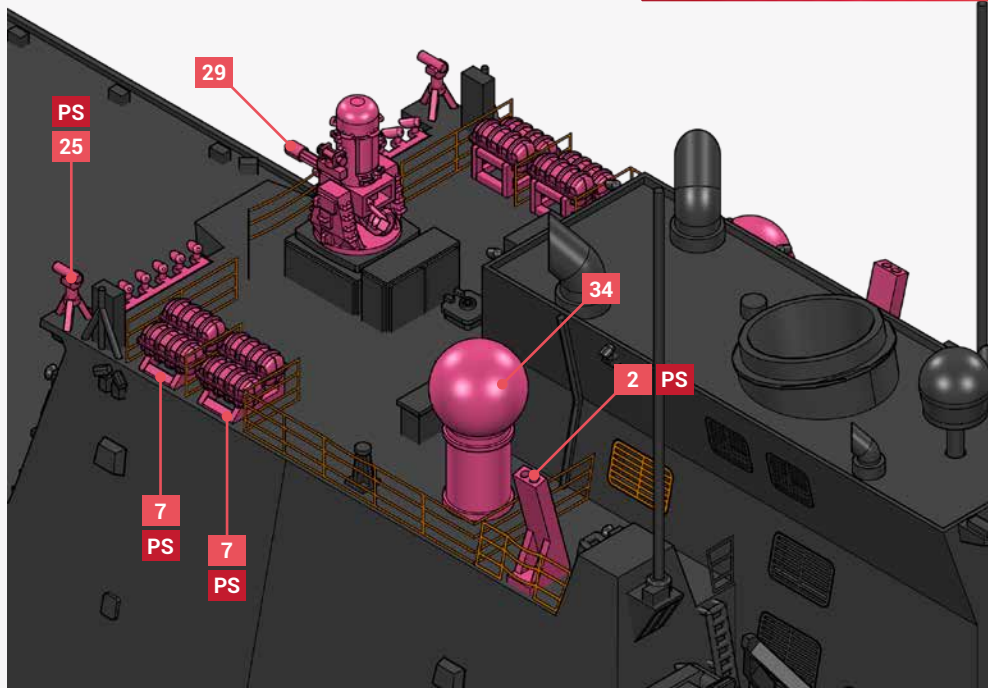



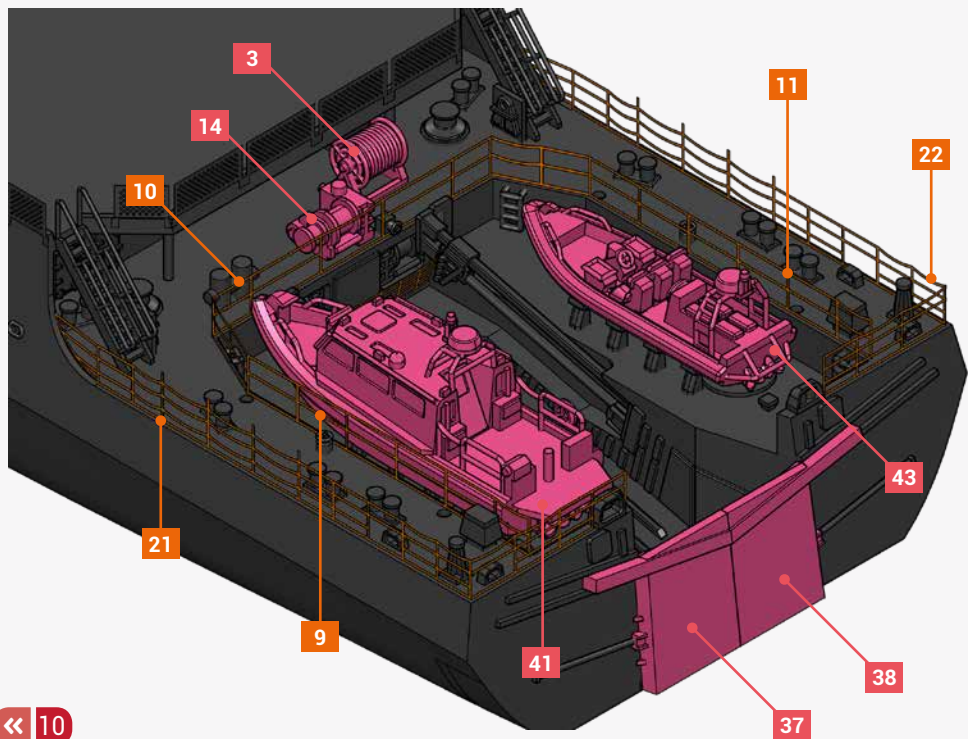
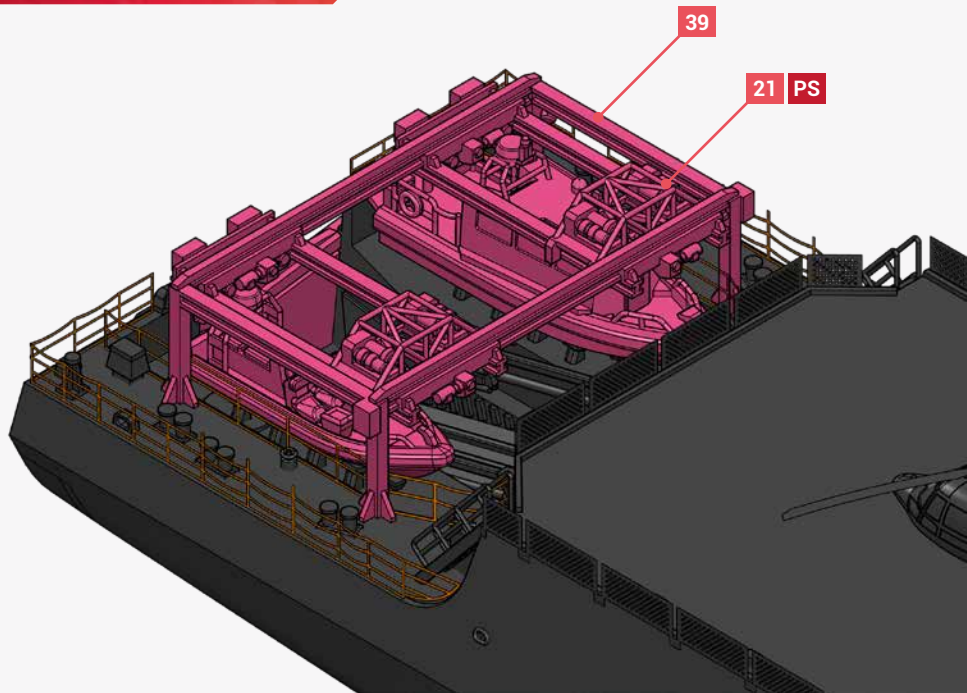

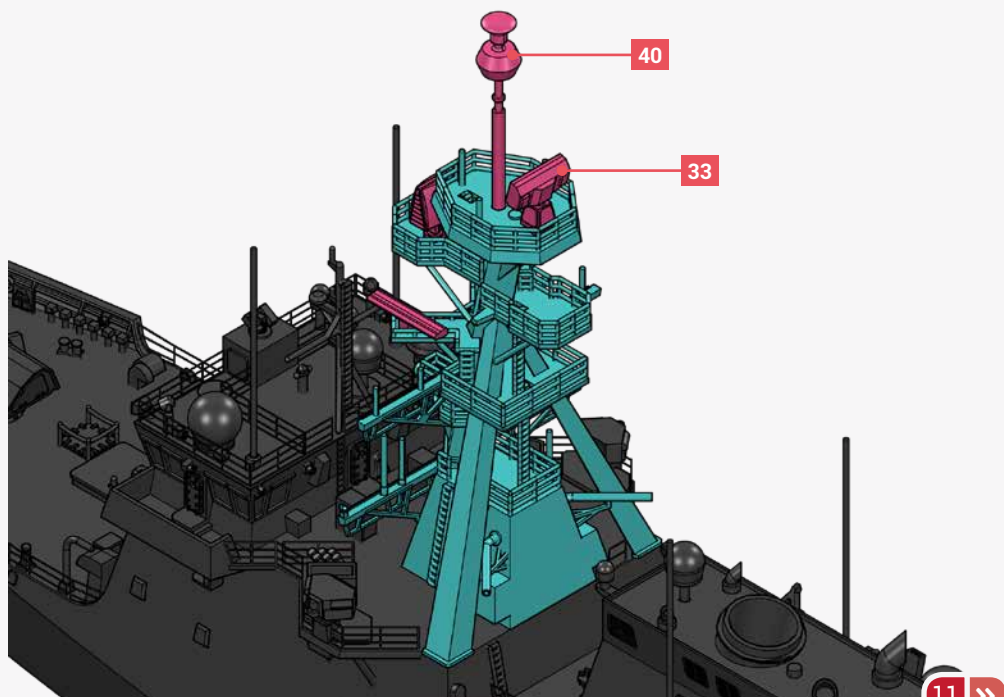
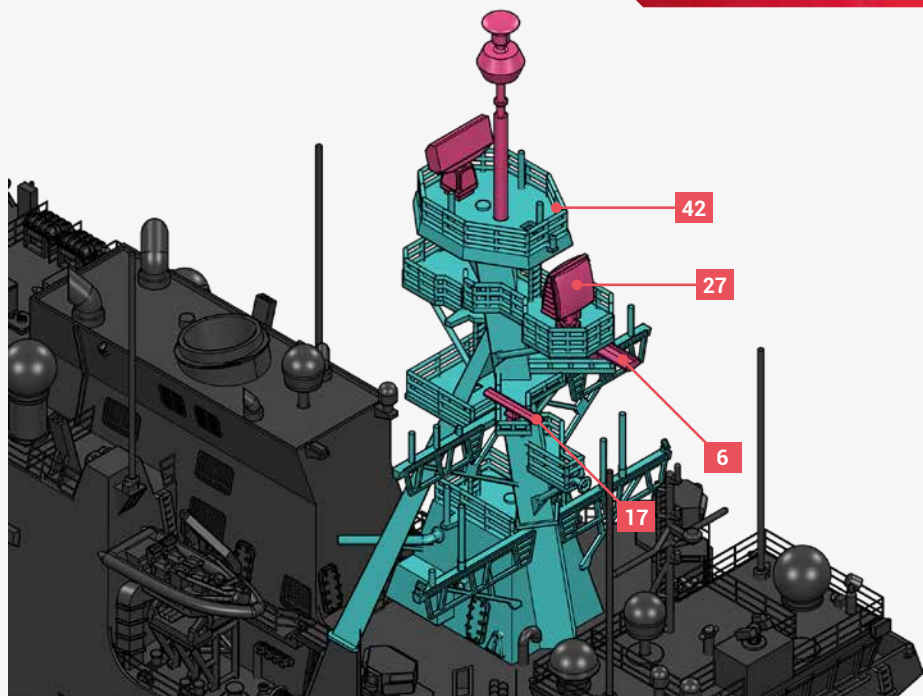

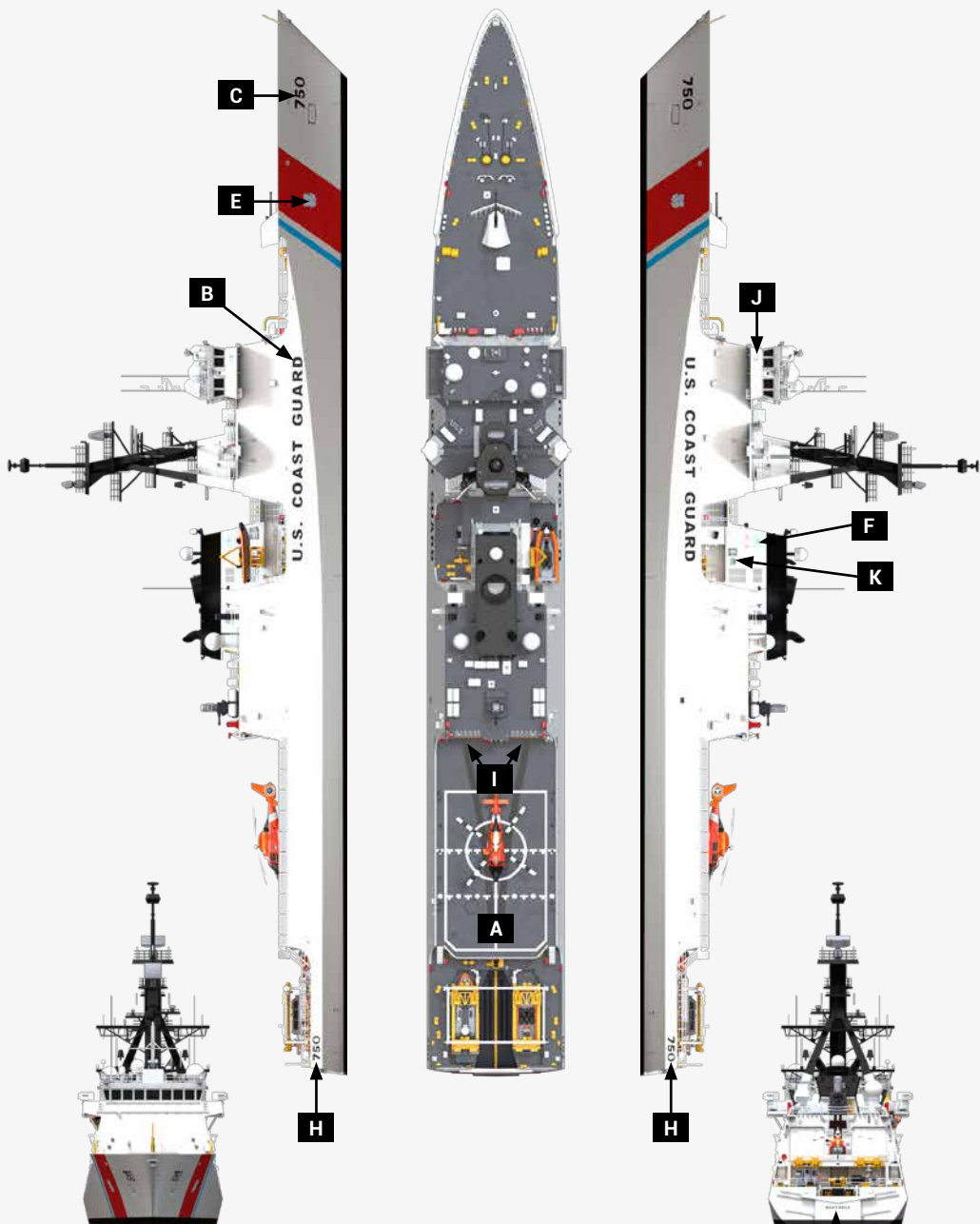

STEP 7







- | | | | |
|---|----------------------|---|------------------|
|  | WHITE HULL |  | BLACK |
|  | CG RED (PMS 181 C) |  | ANTI FOOLING RED |
|  | CG BLUE (PMS 307 C) |  | YELLOW |
|  | DARK GRAY (FS 36077) |  | RED |